

# Oil Review

Oil · Gas · Petrochemicals

Middle East

VOLUME 23 | ISSUE 1 2020

## The oil market 2020 and beyond

- Egypt makes progress as an energy hub
- Prioritising a low carbon future
- Advances in gas detection
- Remote device management
- The impact of IMO 2020

**23**  
Years

Serving the regional oil & gas sector since 1997

# Pressure Measurement Technology for Gas Monitoring and Water Applications

## Series DCX-22 CTD

Data Logger for Conductivity, Temperatur & Level (Pressure)

- ✓ Maintenance-free
- ✓ Autonomous
- ✓  $\varnothing$  22 mm
- ✓ Stainless Steel, Hastelloy or Titanium
- ✓ Logger 5 Software included



## LEO Record (ATEX)

Digital Manometer with Record Function

- ✓ High Accuracy and Resolution
- ✓ Ranges from 30 mbar to 1000 bar
- ✓ Recording Pressure and Temperature
- ✓ Easy selectable Sample Rate and Pressure Units
- ✓ Logger 5 Software included



**Editor:** Louise Waters - ✉ [louise.waters@alaincharles.com](mailto:louise.waters@alaincharles.com)

**Editorial and Design team:** Mariam Ahmad, Prashanth AP Fyna Ashwath, Miriam Brtkova, Praveen CP, Manojkumar K Nonalynka Nongrum, Shalaka Paradkar, Abhishek Paul, Rahul Puthenveedu, Samantha Payne and Deblina Roy

**Managing Editor:** Georgia Lewis

**Publisher:** Nick Fordham

**Sales Director:** Michael Ferridge

**Magazine Sales Manager:** Tanmay Mishra  
☎ +91 98800 75908

✉ [tanmay.mishra@alaincharles.com](mailto:tanmay.mishra@alaincharles.com)

**International Representatives**

**Nigeria** **Bola Olowo**  
☎ +234 8034349299  
✉ [bola.olowo@alaincharles.com](mailto:bola.olowo@alaincharles.com)

**USA** **Michael Tomashefsky**  
☎ +1 203 226 2882 ☎ +1 203 226 7447  
✉ [michael.tomashefsky@alaincharles.com](mailto:michael.tomashefsky@alaincharles.com)

**Head Office:**

Alain Charles Publishing Ltd  
University House, 11-13 Lower Grosvenor Place, London,  
SW1W 0EX, United Kingdom  
☎ +44 (0) 20 7834 7676 ☎ +44 (0) 20 7973 0076

**Middle East Regional Office:**

Alain Charles Middle East FZ-LLC  
Office L2-112, Loft Office 2, Entranca B,  
P.O. Box 502207, Dubai Media City, UAE  
☎ +971 4 448 9260, ☎ +971 4 448 9261

**Production:** Srinidhi Chikkars, Swati Gupta, Nelly Mendes and Arjun S  
✉ [production@alaincharles.com](mailto:production@alaincharles.com)

**Subscriptions:** ✉ [circulation@alaincharles.com](mailto:circulation@alaincharles.com)

**Chairman:** Derek Fordham

**Printed by:** Buxton Press

**Printed in:** January 2020

© Oil Review Middle East ISSN: 1464-9314

## ➔ Editor's note

AS WE ENTER a new decade, a number of factors will influence the oil demand and supply outlook, and consequently oil prices, ranging from the economic growth rate, trade wars and the Washington-Tehran conflict, to the pace of the US shale oil boom and OPEC+ compliance. See our analysis on p14.

How do MENA oil and gas companies view prospects, and what are their priorities for the year ahead? Most are confident of industry growth in 2020, according to a new survey from DNV GL (p22). Interestingly, 70 per cent of MENA respondents are calling for their businesses to decarbonise faster, reflecting the growing focus on sustainability as climate change comes to the top of the agenda. In this issue we assess Egypt's progress to become a gas powerhouse for the Mediterranean region (p18); how technology is driving improvements in gas detection (p26); how AI can unlock efficiency gains across the region's field services industry (p34); and the impact of IMO 2020 on shipping and refining operations (p36).

## ➔ Contents

### Calendar

- 4 Executives' calendar and event news**  
Featuring GEO 2020, IP Week, SABIC Conference and Oman Petroleum & Energy Show

### News

- 8 Developments**  
A round-up of the latest news from around the region

### Oil Market

- 14 The oil market in 2020 and beyond**  
Trends shaping oil prospects in 2020 and beyond

### Egypt

- 18 A Mediterranean energy hub**  
Egypt is on track to become a gas powerhouse for the Mediterranean region

### Offshore Safety

- 20 Turning ideas into products**  
The importance of innovation and continual improvement

### Analysis

- 22 Prioritising a low carbon future**  
DNV GL's latest report assesses industry sentiment and priorities for the year ahead

### Gas Detection

- 26 Advances in gas detection**  
Technology is driving safety improvements in gas detection, delivering greater connectivity, portability and accuracy

### Technology

- 30 Next-gen isolation gasket to address corrosion challenges**  
GPT's fully-coated isolation gasket is able to withstand the harsh environment of the Middle East

- 32 Progressive cavity pumps - API 676 compliance**  
The main issues affecting the compliance of progressive cavity pumps with API 676.

- 34 Transforming field operations with Artificial Intelligence**  
AI can help unlock efficiency gains across the Middle East's field services management industry

### Shipping

- 36 The impact of IMO 2020**  
The impact of IMO 2020 on shipping and refining operations

### Communications

- 38 Digital services for remote device management**  
Benefits of digital services for automated staging, mobile device management and device analytics

### Innovations

- 40 The latest product developments in oil and gas**

### Arabic

- 5 Analysis**

Back cover image courtesy of Saudi Aramco

## → Executives' Calendar 2020

FEBRUARY			
11-13	<b>Egypt Petroleum Show</b>	CAIRO	<a href="http://www.egypt.com">www.egypt.com</a>
17-20	<b>SABIC Conference 2020</b>	JUBAIL	<a href="http://www.sc2020expo.com">www.sc2020expo.com</a>
18-20	<b>ME-TECH 2020</b>	ABU DHABI	<a href="http://www.europetro.com/events">www.europetro.com/events</a>
25-27	<b>IP WEEK</b>	LONDON	<a href="http://www.ipweek.co.uk">www.ipweek.co.uk</a>
MARCH			
2-3	<b>Kuwait HSE Forum</b>	KUWAIT	<a href="http://www.hse-forum.com">www.hse-forum.com</a>
2-4	<b>MERTC</b>	MANAMA	<a href="https://mertc.wraconferences.com">https://mertc.wraconferences.com</a>
3-5	<b>Middle East Energy (MEE) 2020</b>	DUBAI	<a href="http://www.middleeast-energy.com">www.middleeast-energy.com</a>
9-11	<b>Oman Petroleum &amp; Energy Show</b>	MUSCAT	<a href="http://www.middleeast-energy.com">www.middleeast-energy.com</a>
16-19	<b>GEO 2020</b>	MANAMA	<a href="http://www.geo-expo.com">www.geo-expo.com</a>
24-26	<b>OpEx MENA 2020</b>	MANAMA	<a href="http://www.europetro.com">www.europetro.com</a>
30-31	<b>Middle East Petroleum &amp; Gas Conference</b>	MANAMA	<a href="http://www.mpgc.com">www.mpgc.com</a>
APRIL			
13-16	<b>SOGAT</b>	ABU DHABI	<a href="http://www.sogat.org">www.sogat.org</a>
MAY			
4-7	<b>OTC</b>	HOUSTON	<a href="http://www.2020.otcnet.org">www.2020.otcnet.org</a>
JUNE			
15-16	<b>Bahrain HSE Forum</b>	MANAMA	<a href="http://www.hse-forum.com">www.hse-forum.com</a>
18-18	<b>Lebanon Int'l Oil &amp; Gas Summit</b>	BEIRUT	<a href="http://www.liog-summit.com">www.liog-summit.com</a>

*Readers should verify dates and location with sponsoring organisations, as this information is sometimes subject to change.*

## Defining the industry's role, delivering a low carbon future

AS ONE OF the biggest events in the energy sector, IP Week brings together more than 1,500 industry professionals from over 50 countries, making this internationally renowned event the place to hear the latest news and updates, debate critical issues, share ideas and network to form partnerships.

IP Week 2020 takes place from 25-27 February at the InterContinental Park Lane, London. It will explore how the oil and gas industry can be a key player in delivering a low carbon future. While oil and gas supplies remain an essential resource for now, the industry still needs to showcase the actions they are taking to transform how energy is provided to all parts of the world. What organisations, technologies and operations are helping to shape the plan for a cleaner future? This event will bring together the most influential figures in the industry to outline their views, share future plans and explore how the innovation, technology and talent we have at our fingertips will bring about this transformation.

Speakers include Bernard Looney, incoming group chief executive BP, Dr Fatih Birol executive director IEA, HE Mohammad Sanusi Barkindo, secretary general, OPEC, Craig Bennett, chief executive, Friends of the Earth, Al Cook, executive vice president, Global Strategy & Business Development, Equinor and Yu Jiao, vice president, Economic & Development Research Institute, SINOPEC.



*The event will provide a forum for debating critical issues.*

Image Credit: Energy Institute

IP Week's Middle East Summit, held in partnership with Gulf Intelligence, takes place on 27 February, with speakers including H.E. Sheikh Mohamed bin Khalifa bin Ahmed Al-Khalif, Minister of Oil, Kingdom of Bahrain, Dr. Noura Mansouri, chair Think 20 - Saudi Arabia's Climate Change & Environment Task Force, Dr. Falah Al-Amri, advisor, Ministry of Oil, Republic of Iraq and John Roper, CEO Middle East, UNIPER Global Commodities SE.

*For further information see the website at [www.ipweek.co.uk](http://www.ipweek.co.uk).*



# Compact, Robust and Reliable Production Chokes from SAGA-Lancaster

Production chokes play a critical role in the safe and economical delivery of the world's oil and gas reserves. The demands of modern-day oilfield production dictate that safety and reliability is paramount.

For over 20 years, SAGA-Lancaster Flow Automation have designed and manufactured a high-performance production choke, specifically engineered to process aggressive fluids composed of sand and other solid particles.

Our engineering and manufacturing processes are characterized by our commitment to innovation. Our testing and research produce important information, but our best feedback comes from our customers.

The advances in our production chokes reflect the need to accommodate increasing operating pressures while delivering outstanding efficiency and reliability.

We've designed a long list of important advances in our chokes. For example, our equipment requires extremely low operating torque; our stainless operating lever is only 7.5 inches long. There's no need for large hand wheels or additional personnel.

Automation is really simple with a lightweight, low-powered actuator that can be installed while the choke is in service. Any type or brand of actuator is compatible, regardless of the trim type.

A tungsten-carbide trim is standard, however we offer multiple trim types with a single configuration bonnet and body. All seat assemblies utilize a non-threaded design that cannot be loosened from flow-induced vibration; which means there are no seat-to-body seal failures and body damage.

All of our choke bodies are forged and have a reinforced inlet nozzle area and large body reservoirs that reduce internal erosion and extend the trim life span. Our superior manufacturing processes deliver improved corrosion resistance of the standard stainless steel trim components and superior seal performance.

SAGA-Lancaster has manufacturing facilities in Houston, Texas and Samarinda, Indonesia. And, we have a service facility in Abu Dhabi in the UAE.



To learn more information about SAGA-Lancaster Chokes,  
contact [sales@sagapce.com](mailto:sales@sagapce.com)

Singapore, Indonesia, U.S.A., Australia, Oman, UAE

## Boosting Oman's oil and gas sector

AROUND US\$51.1 BILLION of oil and gas projects are planned and underway in Oman, opening big opportunities for investors.

The Oman Petroleum & Energy Show, Oman's largest international oil and gas event, takes place at the Oman Convention & Exhibition Centre from 9-11 March.

The event sees the relaunch of Oil and Gas West Asia (OGWA), as part of a broader event, which also features the SPE EOR Conference and the newly launched Gas & LNG Show, Offshore & Marine Show and Stainless-Steel World Middle East.

Held under the patronage of the Ministry of Oil & Gas of Oman, and hosted by Petroleum Development Oman (PDO), the Oman Petroleum & Energy Show is an effective business and networking platform, serving as a key meeting point for energy professionals, oil and gas companies, policy and decision makers, and stakeholders.

There will be more than 500 exhibitors representing 30 countries and more than 12,000 visitors with 10 country pavilions.

For further information see the website at [www.omanpetroleumandenergyshow.com](http://www.omanpetroleumandenergyshow.com)



Image Credit: Oman Expo

**OPES will be the largest B2B event in the Sultanate of Oman.**

## Fostering innovation in petrochemicals

THE SABIC CONFERENCE 2020 will be held from 17-20 February at the King Abdullah Cultural Center, Jubail, Saudi Arabia. It will provide a platform for debating key issues, developments and technologies in the global petrochemical industry, sharing new ideas and networking to form partnerships with petrochemical operators, clients and investors.

The theme of SABIC Conference 2020 is Chemistry 4.0, where digitalisation, circular economy, sustainability and innovation are the key features.

An impressive line-up of global and local CEOs, heads of manufacturing companies, scientists, researchers, chemists, engineers and technical experts will share their experiences and expertise.

The accompanying Exhibition of the SABIC Conference 2020 is an international platform for SABIC vendors and suppliers and all companies who look to establish business partnerships with SABIC and the major participating companies. It will bring together 35,000 attendees along with 400 exhibiting companies from more than 35 countries.

For further information visit <https://www.sc2020expo.com/>

## Focusing on geosciences in the digital world

FOR 26 YEARS, the GEO exhibition and conference has been at the forefront of petroleum geoscience and the premier meeting place for the Middle East's petroleum geosciences community. It is the Middle East's pre-eminent event for presenting and learning about new developments, applications, geology, geophysics and for networking with community peers and industry experts.

GEO 2020, the 14th Middle East Geosciences Conference and Exhibition, will be held at the Bahrain International Exhibition & Convention Centre Bahrain from 16-19 March.

The conference, coordinated by the American Association of Petroleum Geologists (AAPG), the European Association of Geoscientists and Engineers (EAGE) and the Society of Exploration Geophysicists (SEG), will take place under the theme Geosciences in the Digital World: 2020 and Beyond, covering 16 themes addressing the fast-moving developments in the petroleum geoscience industry.

The GEO exhibition is the premier showcase of oil and gas exploration technology and services in the Middle East, attracting NOCs, IOCs and major operating companies. More than 4,000 attendees and 70 exhibitors will converge for three days of sourcing, networking and education opportunities.

For further information visit [www.geo-expo.com](http://www.geo-expo.com).



Image Credit: Informa Markets

**The event will feature more than 70 exhibitors.**

## Pushing for diversity and inclusion

IN THE LAST few years the Middle East has seen a wave of new generation leaders, with the UAE's cabinet including nine female ministers. Women in the UAE have successfully made inroads into traditionally male-dominated sectors such as aviation, energy, and defence.



Image Credit: MICE Quotient

**The event will celebrate empowered women.**

The fifth edition of the Arab Women In Leadership and Business Summit (5-6 February, 2020) organised by MICE Quotient, celebrates empowered women while recognising their achievements. It will be attended by some of the region's most prominent personalities. These include HE Dr Sharifa Al Yahyai, former Minister of Social Development, Sultanate of Oman; Maryam Bin Theneya, Member, Federal National Council, UAE; HE Reem Bin Karam, director of NAMA; Alyazeya Saeed, the first female cargo manager – Oman, Emirates SkyCargo; Amna Sultan Al Owais, chief registrar, DIFC Courts; Hala Kazim, social entrepreneur; Eida Al Muhairbi, Emirati inventor; Eman Al Mahmoud, head of partnerships, Sharjah Entrepreneurship Center – Sheraa; Hessa Al Ghurair, director human capital, UAE General Civil Aviation Authority (GCAA); Noha Hefny, co-founder, She is Arab; and Samah Al Hajeri, chief innovation officer (CIO), Ministry of Economy - UAE.

Sponsors and supporters include AXA – Gulf, Habibti, Dubai SME, the Dubai Business Women Council, NAMA Women, Young Arab Leaders and AMCHAM Abu Dhabi.

Edwin Paul, CEO, MICE Quotient commented, "The fifth edition of The Arab Women in Leadership and Business Summit is launched so that Emirati women can showcase their skills and achievements by taking centre stage and develop future leaders. The summit will take forward the UAE government's vision of becoming one of the world's top 25 countries for gender equality by 2021 by highlighting diversity and inclusion as one of its key aspects."



## ADNOC named UAE's most valuable brand for second consecutive year

THE ABU DHABI National Oil Company (ADNOC) has been named the UAE's most valuable brand for a second consecutive year by brand valuation and strategy consultancy Brand Finance.

The state-owned oil firm's brand value jumped to US\$11.39bn in 2020, a 28.6 per cent increase over the previous year and a 145 per cent increase since the launch of its transformation strategy in 2017.

This makes ADNOC the fastest-growing brand in the Middle East for 2020 and the first UAE brand to surpass US\$10bn in value.

ADNOC Group CEO Dr Sultan Ahmed Al Jaber received the highest ranking among both MENA region CEOs and national oil company CEOs for brand stewardship and brand value creation.

Over the past 12 months, the most significant drivers of ADNOC's brand value growth included consistency of best practice across the organisation, a strong HSE track record and focus on safety, success facilitating local economic growth and FDI.



Image Credit: ADNOC

## Saudi Aramco Energy Ventures invests in Seeq

SEEQ CORPORATION, MANUFACTURING and industrial internet of things (IIoT) advanced analytics software provider, has secured a US\$24mn expansion of its Series B funding, led by Saudi Aramco Energy Ventures (SAEV), the corporate venture subsidiary of Saudi Aramco.

It includes renewed participation by Altira Group, Chevron Technology Ventures, Second Avenue Partners, and other existing investors.

Seeq enables engineers and scientists in process manufacturing organisations to rapidly analyse, predict, collaborate and share insights to improve production outcomes. Customers include companies in the oil and gas, pharmaceutical, chemical, energy, mining, food and beverage, and other process industries.

"Seeq is providing an important improvement in software for customers in process industries to accelerate insights, action and impact on their production and business outcomes," commented James Sledzik, venture executive at SAEV.

Upon final closing, Seeq expects the Series B expansion to reach approximately US\$30mn, which is in addition to Series B funding led by Altira Group.

## Crescent Petroleum implements sustainability initiatives

CRESCENT PETROLEUM, AN upstream oil and gas company in the Middle East, has outlined a range of efforts to ensure a sustainable future for the company and the region in the decades ahead.

Crescent aims to further reduce its already low level of gas flaring from operations and is implementing plans to eliminate the use of all single-use plastics.

It has continued to improve on a variety of sustainability programmes at its regional operations to reduce its use of water, electricity and fuel, and its overall impact on the environment.

Majid Jafar, CEO of Crescent Petroleum, announced the company's sustainability efforts on the opening panel of the Atlantic Council Global Energy Forum in Abu Dhabi.

Crescent has worked to cut its carbon intensity per barrel equivalent to less than one-third of the industry average, with plans to reduce it even further. Moreover, Crescent Petroleum has brought its overall flaring down to 0.7 per cent of production, with aspirations to bring that figure down to nearly zero in the coming years.

The company stated that its gas production over the past decade has itself helped avoid 33mn tonnes of CO2 by replacing diesel with gas to generate power. That reduction is the equivalent to removing all the UAE's nearly three million cars off the road for two years and PwC estimates that this impact will more than triple in the coming decade.



Majid Jafar is the CEO of Crescent Petroleum.

Image Credit: Chatham House/Flickr

## Gradiant Energy Services signs MoU with NESR for MENA

GRADIANT ENERGY SERVICES (GES), a leading service provider for produced and flowback water treatment and recycling solutions, has entered into a MoU agreement with oilfield services provider National Energy Services Reunited Corp (NESR).

The MOU sets forth the terms and understanding between both companies to deploy GES technologies and equipment in the MENA region where NESR operates. Both companies are set to join efforts to bring GES unique water technical solution capabilities, leveraging NESR's strong operational reputation, footprint and resources in the Middle East and Asia.



Image Credit: navimtar/Adobe Stock

*The MOU sets forth the terms and understanding between both companies to deploy GES technologies and equipment in the MENA region.*

"GES is regarded as the company of choice for unique and tough water challenges. Our track record across the space is the result of our deep expertise around water solutions," said Danny Jimenez, chairman and CEO of GES.

"Middle East oil and gas operators have learned about the value we bring to clients in places like the Permian and over the last year or so, we have received direct inbound requests from relevant operators in that region to provide them with our technical solutions. When we explored ways to enter the market, we found NESR's presence and strong reputation in the region to be a unique combination for a partnership."

Sherif Foda, CEO and chairman of the Board of NESR, commented, "We believe that sustainable water strategies and preserving freshwater resources need to be front and centre in the execution of the extensive unconventional and conventional gas programmes in the region."

"Water conservation, in every area we operate in, is an important pillar of NESR's overall ESG strategy. NESR is taking the lead in introducing technologies and know how, to help our customers continue to produce in an environmentally sustainable manner from these reservoirs."



Lining Material: PTFE/PFA/FEP/PVDF/PP/HDPE

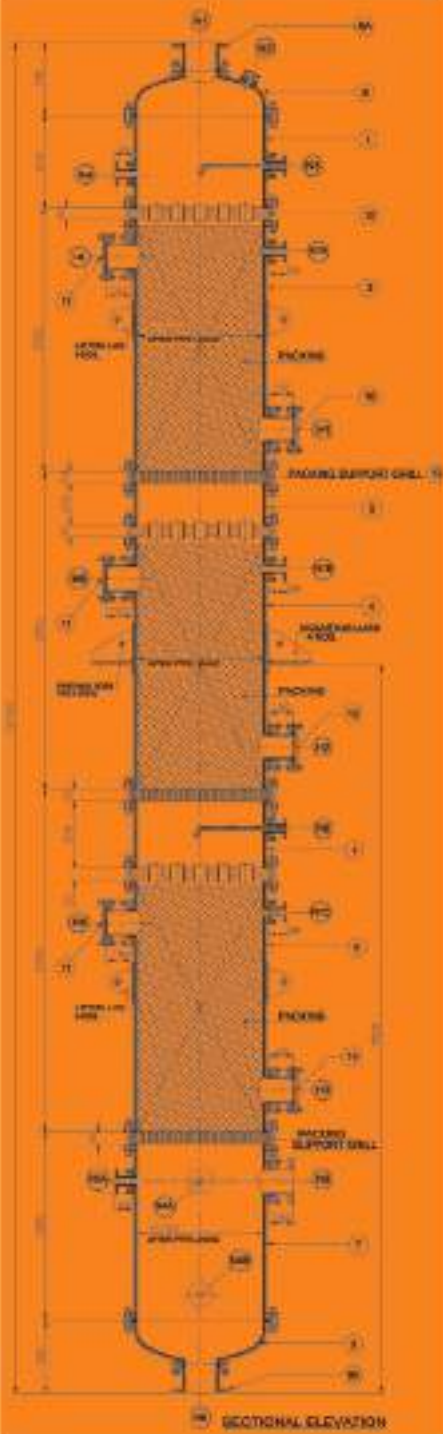

### Why Resistotech:

- Processing capacity of 50+ tonnes per month
- Large diameters upto 2000 NB (80") by paste extrusion
- Liners thickness from 2 mm to 14 mm as per application
- Seamless lining in Tanks, column and vessel – no weld joints
- Liner lengths 6400 mm upto 400 NB and above all 3200
- All sizes 90 Deg Elbows in single piece
- Minimizing joints by longer lengths -saves product and installation cost
- Full vacuum upto 200 Deg C in any size
- Testing as per ASTM F 1545 – 03 for 100% products
- FDA certificate and compliance

Techno-commercial solutions provider with pre-engineering and case study of corrosion issues

## RESISTOTECH INDUSTRIES PRIVATE LIMITED

C-11, MIDC, SINNAR, DIST.: NASHIK, MAHARASHTRA, INDIA, PIN - 421 301.

M: 0091 9820429054 | T: 0091 2551 230540 | E: sales@resistotech.com | W: www.resistotech.com

## Energy transition puts extra pressure on exploration, says Wood Mackenzie

THE EXPLORATION SECTOR heads into 2020 facing increasing pressure from the energy transition, according to research and consultancy group Wood Mackenzie.

While capital discipline and portfolio high-grading remain vital, the shift to a low-carbon world poses a fundamental challenge, and this year is likely to show the sector's direction of travel in the years ahead.

Alana Tischuk, from Wood Mackenzie's global exploration team, said, "Some investors are questioning the need to explore at all given the vast discovered resource base yet to be developed.

"However, lower-carbon opportunities very often have lower costs and better economics. The challenge is to achieve success at scale.

"Companies will drill in the hope of finding better resources than those they already have – lower-cost barrels with a higher margin."

She said that while new opportunities exist, these large, valuable prospects lie mostly in new and emerging plays. The majors are likely to remain prominent participants in high-impact exploration plays. NOCs, which are less exposed to investor concerns, may also be able to step up their exploration game.

Some companies may announce a strategic move towards acquisition-led growth or new energy businesses. Others are boosting their gas portfolios, viewing it as the fuel that will power the energy transition.

Tischuk said, "The move towards gas shows that exploration is not mutually exclusive with a low-carbon future. A diverse inventory of low-breakeven opportunities will be key as the energy transition unfolds. Those prospects with a clear route to commercialisation are likeliest to be drilled."

## Wood secures two-year extension for Saudi Aramco unconventional gas programme

BRITISH ENERGY SERVICES company Wood has secured a two-year extension to its in-Kingdom and out-of Kingdom contracts with Saudi Aramco's subsidiary, Aramco Overseas Company B.V. (AOC).

The contract is for Saudi Aramco's unconventional gas programme, originally secured in 2014.

Wood's project execution teams will continue to work closely with Saudi Aramco to develop innovative engineering design and implementation strategies to

deliver the programme's primary objective to produce and deliver significant volumes of gas from shale and tight gas reservoirs.

Unconventional gas is vital to meeting Saudi Arabia's growing energy needs, with cleaner-burning natural gas for domestic power generation. Developing unconventional resources requires logistics that differ from those of standard conventional gas as well as a bespoke strategy to maximise efficiency and economic viability.



Image Credit: photolibrary/Adobe Stock

*Unconventional gas is vital to meeting Saudi Arabia's growing energy needs.*

## SNC-Lavalin wins oil and gas contract

ENGINEERING COMPANY SNC-LAVALIN has been awarded an engineering services contract from Al Dhafra Petroleum, a joint venture company between ADNOC and the Korea National Oil Corporation and GS Energy.

This contract win is aligned with the company's new strategy moving forward to greater growth and engineering services.

Under the nine-month agreement, the company will provide front-end engineering and design (FEED) services for the second phase of the Haliba field, located in Al Dhafra Petroleum's concession area.

The project's aim is to develop surface facilities in an optimised manner to handle long-term production as well as future production prospects near Haliba. The contract scope of work includes verification of the conceptual studies and design, carrying out FEED to develop surface facilities required for processing production from the main plant and its north and south extension areas, execution planning, and designing facilities to handle production from other close-by prospects.



Image Credit: SNC-Lavalin

*Craig Muir is president, resources at SNC-Lavalin.*



### SHREE STEEL OVERSEAS FZCO

STOCKIST OF PIPES, FITTINGS, FLANGES, GASKETS AND STUD-BOLTS





Flat No 5-50907, Jebel Ali, Free Zone (South), P.O. BOX 17729, Dubai-United Arab Emirates

Telephone: +9714-8865119  
Fax: +9714-8865118  
Email: sales@ssoc | info@ssoc  
www.shreesteeloverseas.com

Branches: (1) Shree Oilfield Supply LLC  
Global Ascent Business Center,  
Office No : 5, Block 2 - Unit 18, M4, Plot 12,  
Near Muroffah Saraya - Abu Dhabi, UAE  
Tel : +9712-6214280, Fax : +9712-6214289

(2) Steel Piping Solutions LLC  
Muscat, Oman

Emergency Mobile No: **00971 50 3752010**

## Saudi minister highlights sustainable energy approach

HRH PRINCE ABDULAZIZ bin Salman bin Abdulaziz Al Saud, Minister of Energy, Saudi Arabia, shared his country's approach towards sustainable energy at the Future Sustainability Summit held in Abu Dhabi in January.



HRH Prince Abdulaziz bin Salman bin Abdulaziz Al Saud.

Image Credit: Alain Charles Publishing

He said that adding more renewables to the country's energy mix will enable the country to export more oil.

But their approach didn't just end there. He explained, "We are building an energy strategy where we are focusing more on our energy mix, asking the question what would be more effective in Saudi Arabia, free of any bias, looking at the economics rather than pre-conceived preferences that we may have had in the past."

He said the best power mix for Saudi Arabia was gas and, but that certain areas were still reliant on oil where consumption was high.

He declared that Saudi Arabia aims to have developed its gas resources by 2030 and extended its renewables portfolio, with ambitious plans to reduce emissions by 70 per cent.

"Our inspiration in terms of renewables is not just preparing our own domestic demand but also manufacturing and exporting a huge amount of it if we can," he told delegates.

Prince Salman bin Abdulaziz Al Saud said the aim was to develop the nation's local companies and make sure that they become as competitive as Masdar, the UAE's pioneering clean energy company.

He wanted to introduce an equal playing field for all sources of energy for the country and adopt the concept of a "circular economy" as the right solution and way forward.

"Regardless of the source of energy you use, so long as you mitigate the impact and sequester the impact of emission gases," he said.

He continued, "In our concept of a circular economy we are saying you can go further. If you sequester it, you can use carbon as a material, then manufacture it, and use it and monetise the material. It will be a win win situation."

## ADNOC signs CCUS agreement with Eni

ADNOC HAS SIGNED a strategic framework agreement with Italy's energy company, Eni, to explore new opportunities for collaboration in carbon capture utilisation and storage (CCUS), where ADNOC is an industry leader, and additional strategic opportunities in research and development (R&D) across the oil and gas value chain.

Under the terms of the agreement, ADNOC and Eni will jointly explore opportunities for collaboration in relation to innovative geomechanical and geochemical workflows for CCUS programmes, as well as in advanced analysis and modelling of thermally induced fractures in oil and gas reservoirs.

The agreement builds on ADNOC's recently announced sustainability goals, particularly its commitment to decrease its greenhouse gas (GHG) intensity by 25 per cent by 2030, enabled by its industry-leading CCUS programme.

HE Dr. Sultan Ahmed Al Jaber, UAE Minister of State and ADNOC Group CEO said, "The agreement underscores ADNOC's targeted approach to value-add partnerships that is enabling us to maximise value from Abu Dhabi's hydrocarbon resources as we deliver our 2030 smart growth strategy."



The signing of the agreement.

Image Credit: ADNOC

## More action on climate change needed - IEA

THE OIL AND gas industry needs to step up efforts to combat climate change, according to the IEA's recently released *The Oil and Gas Industry in Energy Transitions* report. While some oil and gas companies have taken steps to support efforts to combat climate change, the industry as a whole could play a much more significant role through its engineering capabilities, financial resources and project-management expertise, the report says.

"The first immediate task for all parts of the industry is reducing the environmental footprint of their own operations," said Dr. Fatih Birol, the IEA's executive director. "As of today, around 15 per cent of global energy-related greenhouse gas emissions come from the process of getting oil and gas out of the ground and to consumers. A large part of these emissions can be brought down relatively quickly and easily."

Reducing methane leaks to the atmosphere is the single most important and cost-effective way for the industry to bring down these emissions. But there are ample other opportunities to lower the emissions intensity of delivered oil and gas by eliminating routine flaring and integrating renewables and low-carbon electricity into new upstream and LNG developments.

"Also, with their extensive know-how and deep pockets, oil and gas companies can play a crucial role in accelerating deployment of key renewable options such as offshore wind, while also enabling some key capital-intensive clean energy technologies – such as carbon capture, utilisation and storage and hydrogen – to reach maturity," Dr. Birol added. "Without the industry's input, these technologies may simply not achieve the scale needed for them to move the dial on emissions."

Some oil and gas companies are diversifying their energy operations to include renewables and other low-carbon technologies. However, average investment by oil and gas companies in non-core areas has so far been limited to around one per cent of total capital spending, with

the largest outlays going to solar PV and wind.

An essential task is to step up investment in the fuels – such as hydrogen, biomethane and advanced biofuels – that can deliver the energy system benefits of oil and gas without net carbon emissions, said Dr. Birol.

"The scale of the climate challenge requires a broad coalition encompassing governments, investors, companies and everyone else who is genuinely committed to reducing emissions," said Dr. Birol. "That effort requires the oil and gas industry to be firmly and fully on board."

Dr. Fatih Birol, executive director, IEA.



Image Credit: Friends of Europe/Flickr

## Marjan expansion tops offshore project approvals in 2019

SAUDI ARABIA'S MASSIVE Marjan expansion was the largest offshore project approved worldwide in 2019 measured by total Greenfield capex, with the Berri expansion in third place, according to a report by Espen Erlingsen, head of upstream research at Rystad Energy. With close to US\$12bn in investments, the Marjan project aims to add 24 new offshore platforms to handle initial oil and gas processing and water injection.

The second largest project is the first phase of Total's Area 1 development in Mozambique, while Chevron's Anchor field development in the USA is the largest project within the Atlantic region, just ahead of the second phase of Equinor's Johan Sverdrup field in Norway.

Globally, the amount of oil and gas resources approved for development last year surpassed 20 billion barrels of oil equivalent (boe), the highest level seen since 2011, and indicating that a new cycle of offshore investment is in the making, according to the report. Free cash flow reached nearly US\$90bn, underlining the point that E&Ps have enough cash in hand to invest in new projects after several years of restrained capital expenditure. Total greenfield investments approved last year increased by 50 per cent versus 2018, driven by some very large developments. Total offshore capex grew by five per cent versus 2018, with a seven per cent rise in deepwater spending and a three per cent boost in investments on the continental shelf. For 2020, offshore investments are on track to grow eight per cent, with deepwater up 12 per cent and shelf spending up two per cent.

On the exploration front, Rystad Energy forecasts a dramatic increase in Middle East offshore exploration spending, led by the UAE, which will see upstream investments reach almost US\$1bn by 2025.

Top 15 approved 2019 offshore projects by greenfield capex and facility type\*

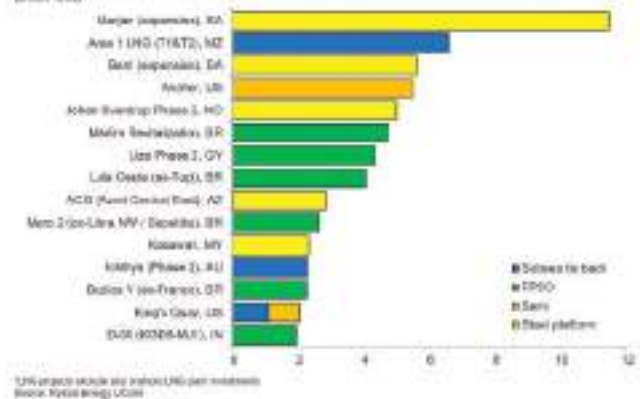
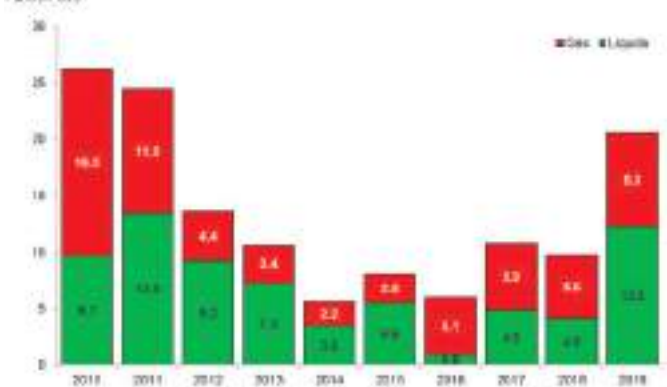

Image Credit: Rystad Energy

Approved offshore resources by oil and gas and sanctioned year



Source: Rystad Energy US&C

Middle East offshore exploration spending

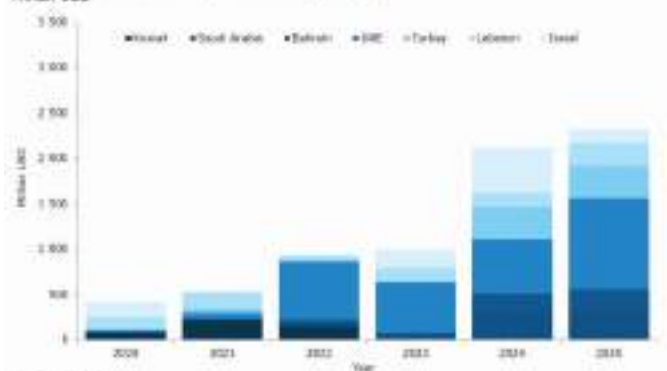

Source: Rystad Energy US&C

The UAE has seen a series of successful licensing rounds with close to 31,000 sq km of acreage being awarded, both offshore and onshore. Following the success of the first bidding round, ADNOC has launched a second competitive bidding phase which would offer unconventional blocks for the first time. In 2019 Kuwait signed a US\$600mn offshore exploration contract with Halliburton to drill six high-pressure high-temperature (HP/HT) exploration wells in the next two to three years, restarting the country's offshore legacy after a more than 30 year hiatus. Saudi Arabia could see a sizeable surge, with investment reaching US\$300mn or more based on the results of the feasibility study from its Red Sea and other offshore areas. Bahrain could also potentially see a dramatic rise from just US\$10mn in 2020 to US\$230mn in 2025. It is currently evaluating the commerciality of its largest ever oil discovery in the offshore Khalij Al-Bahrain Basin in 2018.

### A commitment to Performance and Quality





Are you searching for reliability and High-Quality pipes?

We manufacture Straight Seam (L.S.A.W) and Helical Seam (H.S.A.W) of Carbon steel in diameters ranging from 20 to 84 inches, high strength API line pipe.

Our products conform to Saudi Aramco and international standards.







**National Pipe Co. Ltd.**  
 P.O. Box 1099 Al Khobar 31952, Saudi Arabia  
 Tel: (013) 882 5266 Ext. # 121, 122, 125 & 129  
 Fax: (013) 882 5435 Email: sales\_dept@npc.com.sa  
 Web: www.npc.com.sa

## SNOC announces first gas discovery in three decades

THE SHARJAH NATIONAL Oil Corporation (SNOC) and its partner Eni, have announced a successful new discovery of natural gas and condensate onshore in Sharjah. The discovery, named 'Mahani' comes within the first year of the partnership and represents the first onshore discovery of gas in the emirate since the early 1980s.

The Mahani-1 exploration well, located in the Area B Concession, is the first exploration well drilled by SNOC following the acquisition of a new 3D seismic survey covering the territory, the national energy company said in a statement. SNOC and Eni are also partners in Concession Areas A and C, located onshore Sharjah.

"The launch of the International Competitive Exploration Licensing Round by the Sharjah National Oil Corporation (SNOC) in 2018 has enabled new and valuable strategic partnerships. This discovery is a promising development for SNOC and meets our commitment to make reliable gas supplies available throughout the United Arab Emirates," said His Excellency Sheikh Sultan

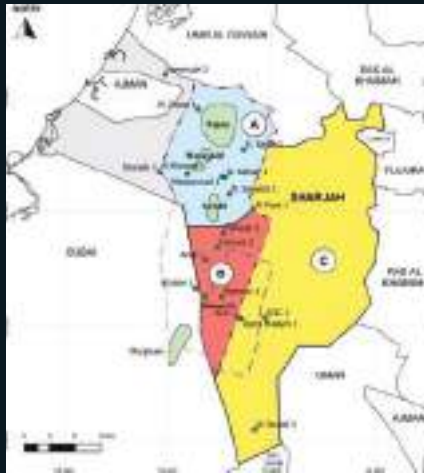

The Sharjah concession map.



The Mahani-1 exploration well.

bin Ahmed Al Qasimi, president of SNOC.

Mahani-1 was drilled to a total measured depth of 14,597 ft. and has encountered gas with associated condensate within the Thamama Group, the primary target for the

well. The well has tested gas at flow rates of up to 50 MMSCF/D, together with associated condensate. The size of the discovery will be further evaluated in due course, with additional drilling expected.

## PDO drills 1,000th well at Marmul



The achievement was a product of a collaborative effort across multiple teams and functions.

PETROLEUM DEVELOPMENT OMAN (PDO) has drilled the 1,000th well at Marmul-Rahab-Thuleilat-Qaharir (RTQ) cluster located in South Oman.

MM-1000 was part of an accelerated programme to boost production by secondary recovery. Its delivery was doubly impressive as the well was commissioned in merely 16 hours from the rig move.

PDO Oil South director Salim Al Sikaiti said, "It is quite remarkable what Marmul has accomplished to date, and the vision is to grow further with another 1,000 wells in the future.

"It is great to see the Marmul cluster sustaining high oil rates after 40 years of extended production, given the advanced maturity of some of these fields and their respective developments."

The Marmul cluster holds a significant portfolio of hydrocarbon volumes contributing an average of 81,600 barrels per day (bpd). It features complex applications undergoing secondary and tertiary recovery mechanisms (including alkaline surfactant polymer injection), underpinned by state-of-the-art technology.

Around 500 more wells are to be drilled in the coming few years in various fields in the cluster through the Marmul Polymer Phase 3 development and denser waterflood in-fill projects that will further boost production and add to the nation's reserves.

# SURAJ

India's Leading Manufacturers of  
Stainless Steel  
Seamless Pipes, Tubes, 'U' Tubes,  
Flanges & Fittings with Electropolishing.





Fast response, Guaranteed Quality. In a large Stock & Production Range.  
Deliver Customized Near Net Shape & Finish with Smaller to Large Quantity.  
All Required Testing Facility Available In-house.  
We are Supplying under all Customer & Third Party Inspection Agencies.



## SURAJ LIMITED

Serving World Wide Oil, Gas & Power Industries

REGD OFFICE :- SURAJ HOUSE,  
OPP. LISHMANPURA GARDEN,  
ASHRAM ROAD, AHMEDABAD - 380 014  
GUJARAT (INDIA)  
PHONE : 8881 - 78 27380120, 27380721  
FAX NO : 8881 - 78 27340722  
E-mail : suraj@surajgroup.com

MUMBAI OFFICE :-  
313/17, BLOCK NO 3, 1ST FLOOR,  
KANEJ NANSOJI, S.V.P ROAD,  
MUMBAI - 400 094 (INDIA)  
PHONE : 0091 - 22 22050184, 66362534  
FAX NO : 8881 - 22 22834979  
E-Mail : surajm@surajgroup.com

www.surajgroup.com  
*Progress is Life*

# The oil market in 2020 and beyond

Moin Siddiqi, economist, assesses trends shaping oil prospects in 2020 and beyond.

**T**HE OIL FUTURES market is showing slightly bullish signs, with front-month contracts for Brent trading at a premium to longer-dated ones. A large premium is typically associated with a tighter market. However, the following overarching factors will continue to influence the demand and supply outlook for world's most heavily traded commodity, and consequently for crude oil prices.

## 1. Sluggish global economy

The Paris-based Organisation for Economic Co-operation and Development (OECD) expects global gross domestic product (GDP) to remain within a 2.9-3.0 per cent range through 2021 – the weakest rate of growth in a decade.

“Two years of escalating conflict over tariffs, principally between the U.S. and China, has hit trade, is undermining business investment and is putting jobs at risk,” the OECD warned. Last year, global trade volumes fell sharply to 1.2 per cent compared to three per cent in 2018, according to the World Trade Organisation (WTO). Industrial production has also stagnated and automakers reported ‘double-digit’ declines. “The world has just lived through an industrial recession,” Bank of America Merrill Lynch noted, and oil prices were underpinned by massive supply outages in 2019.

Crude oil constitutes more than one third of global energy supply, and current expectations for 2020 consumption growth at one per cent (OPEC data) are consistent with previous global downturns (1975, 1982, 1991, 2009). The sectors reporting the sharpest slowdown to date, chiefly trade and industry, are major oil users. Transportation comprises around three fifths of total final oil consumption, while industrial activity (notably petrochemicals) accounts for 27 per cent.

“The slowdown in trade volumes has already affected bunker deliveries. It has also had a strong impact on truck transportation and thus diesel consumption,” the International Energy Agency (IEA) said.

## 2. Protectionism weighing on business sentiment

There are three separate trade conflicts, which are unhelpful for global oil demand – the first between the U.S. and China, the second between Japan and South Korea and, more recently, the transatlantic one between the European Union (EU) and U.S. According to the Institute of International Finance (IIF), rising trade barriers have led to a “synchronised economic slowdown,” including falling imports. Washington-Beijing trade frictions carry the most weight on industrial activity globally.

“A resolution between the two ‘superpowers’ should improve growth outlook and oil demand.”

World oil supply, yearly average (mn bpd)			
	2019	2020	% chg 2020/19
Conventional	74.39	73.59	-1.1
Extra heavy oil	4.01	4.09	2.0
Oil sands	2.75	2.84	3.2
Oil shale (Kerogen)	0.02	0.02	-
Other liquids	5.71	5.82	1.9
Tight liquids plays	10.96	12.44	13.5
Unconventional gas	2.80	2.99	6.8
TOTAL	100.65	101.80	1.1

**Five largest crude oil producers, 2019 est. (mn bpd): USA (12.24); Russia (11.49); Saudi Arabia (9.78); Canada (5.50); Iraq (4.68), representing 43 per cent of global production.**

Sources: King Abdullah Petroleum Studies & Research Centre, U.S. Energy Information Administration, OPEC Secretariat

## The major forecasters of global oil demand (mn bpd)

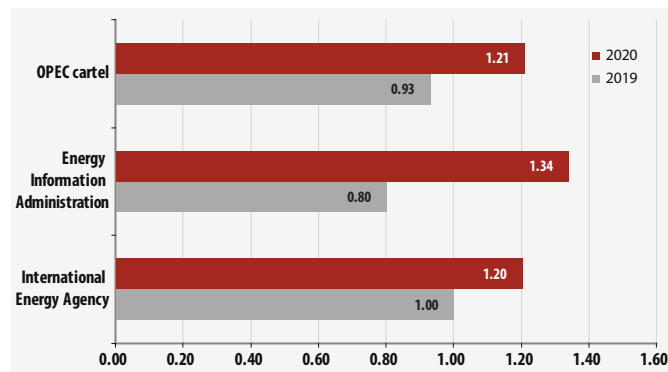

Global 2019 oil demand was at its weakest since the 2008/09 financial crisis

Sources: Latest oil market reports published by above institutes

Note: Demand growth in 2020 could fall within the range of 800,000 bpd to 1.4mn bpd, according to oil analysts surveyed by Reuters.

“This (trade war) is a major drag on oil prices; without this factor, prices would be US\$5-10 higher,” reckons Commerzbank. The International Monetary Fund (IMF) estimated that intensification of U.S.-China trade tensions would cumulatively reduce global GDP by 0.8 per cent in 2020. Conversely, a resolution between the two ‘superpowers’ should improve growth outlook, oil demand trajectories, and, importantly, sentiment. Bank of America commented: “Any signs of improvement on the trade front could add upward pressure to cyclical energy and metals prices.”



# TMK UP MOMENT

High torque  
connection

## APPLICATION:

- Extended-reach wells (ERD)
- Casing while drilling technology (CwD)



The removal of some tariffs could weaken the U.S. dollar, hence raise commodity prices. However, a comprehensive breakthrough in U.S-China negotiations looks challenging.

### 3. The pace of the U.S. shale oil boom

Overall activity is slowing, thanks to reduced capital expenditure (capex) from drillers, but the U.S. will still remain a key contributor to non-OPEC supply expansion this decade. Both the U.S. Energy Information Administration (EIA) and the IEA project U.S. output rising by over 1mn bpd this year – nearly enough to cover the expected increase in global demand. Rystad Energy expects U.S. shale to reach 11.6mn bpd by 2022 (based on WTI averaging US\$55/barrel) – which would represent a compound annual growth rate of 10 per cent on 2019 levels.

OPEC also envisages the continuation of the U.S. shale boom, with light tight oil constituting the bulk of new global supply over the next five years. It projects U.S. tight oil soaring by another 5.3mn bpd, thus taking total output to 17.5mn bpd by end-2030. According to industry experts, U.S. shale will have drilled out most of the recoverable reserves by 2024, leaving a gap in global oil supply that only newly discovered conventional resources could, to some extent, fill.

Shale operations are more capital-intensive than many conventional oil projects. According to Rystad Energy, investments in U.S. shale oil fell six per cent last year, to some US\$129bn, and could drop further, by another 11 per cent in 2020. The main reason for cutbacks in capex is a renewed emphasis on cash discipline and free cash flow generation. Moreover, shale drillers face more than US\$40bn debt maturing this year (Moody's Investors Service data).

“The US will remain a key contributor to non-OPEC supply expansion.”

### 4. Will OPEC+ compliance extend beyond Q1 2020?

OPEC+ Russia need to maintain current ceilings, since major forecasters see an oil supply surplus. Inventories rose in 2019 – OECD commercial stocks were almost 3bn bbl. The cartel may need to take further action to rebalance the market.

A number of factors will influence the supply and demand outlook.

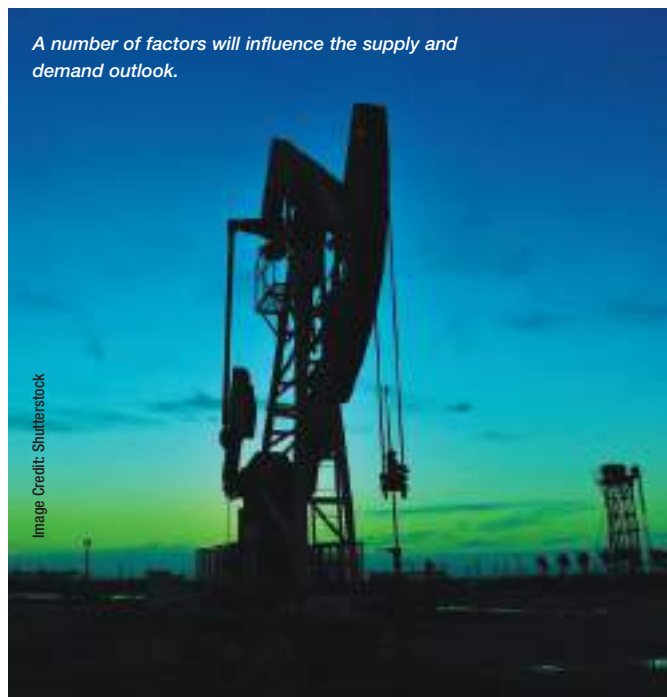

Image Credit: Shutterstock

### The pace of demand growth (mn bpd)

	2019	2020	% chg 2020/19
OECD*	47.99	48.08	0.18
of which: U.S.	20.94	21.01	0.76
Non-OECD regions**	51.77	52.90	2.2
of which: China	13.06	13.39	2.5
Global demand	99.77	100.98	1.2

\*The Organisation for Economic Co-operation and Development  
\*\* Includes Former Soviet Union (Russia) and emerging Europe.

Source: OPEC Secretariat

Note: Demand for oil is dominated by transportation (cars, trucks/ trains, planes and boats) and industry (plastics, fertilisers, steam/heat). Passenger vehicles comprise around a quarter of total oil demand.

### The world's ten largest oil consumers, per cent share of 2018 total: 99.84 (mn bpd)

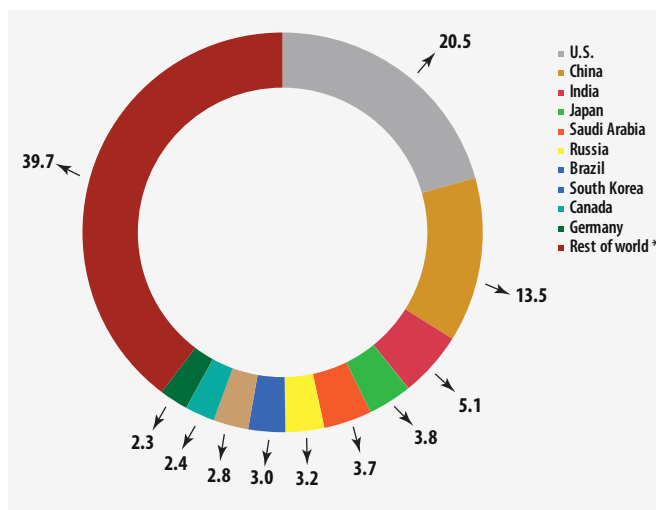

\*Incl. mainly Iran (1.9%); Mexico (1.8%); Indonesia (1.7%); UK (1.6%); France (1.6%); Singapore (1.5%); Thailand (1.5%); Spain (1.3%); Italy (1.3%); Australia (1.1); and UAE (1.0%).

Source: BP Statistical Review of World Energy, June 2019

“If oil demand growth in 2020 were to disappoint again, OPEC+ will face an uphill task in rebalancing the market,” noted Wood Mackenzie. In all probability, unless OPEC extends cuts of 2.1mn bpd (including 400,000 bpd of Saudi volunteer reduction) into H2 2020, oil could fall well below US\$60/bbl.

“Markets can balance with an extension of OPEC cuts through 2020, as new IMO 2020 regulations will create more demand for crude oil. Moreover, the global economy needs to avoid a sharp slowdown and oil demand recover to more normal growth rates of between 1mn and 1.2mn bpd,” said Rystad Energy. Analysts at J.P. Morgan believe the cuts may be extended until end-2020. OPEC’s December 2019 production was reported at 29.6mn bpd (Rystad data). The cartel’s new implied Q1 2020 target is 29.2mn bpd.

However, sudden supply outages in Libya, Venezuela, Nigeria, Iran and Iraq (all OPEC members) could trigger higher prices, while spare capacity outside of Saudi Arabia is limited to Kuwait and the UAE. A regime change in Venezuela – a necessary precursor for lifting of U.S. sanctions – would not automatically result in increased supply, as years of underinvestment means that huge new upstream investments are required to return to pre-sanctions export levels. Venezuelan output slumped to below 1mn bpd at end-2019, compared to 3.23mn bpd in 2008.



## 5. The IMO rules (effective 1 January 2020)

Regulatory changes affect the 4mn bpd market for bunkering fuel by lowering sulfur concentration limits from 3.5 to 0.5 per cent unless the vessel has a scrubber – equipment that strips sulfur emissions from the fuel. The International Maritime Organisation's rules are expected to be followed by the International Air Transport Association's Carbon Offsetting Reduction Scheme for International Aviation (CORSIA) from 2021.

Crude offtake will be boosted as shippers and refiners switch to cleaner (more expensive) low-sulfur fuels. New regulations will have a positive environmental impact, but could cost the global economy US\$1 trillion over five years and conservatively hike prices by an average of US\$7/barrel in 2020, according to S&P Global Platts Analytics, the energy pricing agency. Meanwhile, consumption of heavy oil (high-sulfur fuel) will decline by 2mn bpd based on Wood Mackenzie estimates – equivalent to two-thirds of maritime transport sector demand currently. Kuwait Petroleum Corporation (KPC) research found that only one third of global refineries can supply fuel specs (less polluting fuels) by 2020.

## 6. The Asian 'power houses'

China and India together comprise almost one fifth of the world's oil consumption – their respective shares are expected to increase further. In China and India – each with a population equivalent to that of 36 OECD countries – annual oil demand has risen by 5.5 and 5.1 per cent, respectively, since 2008 (BP data). By contrast, U.S. oil demand rose just 0.5 per cent in the last decade. Both countries are key price drivers, reflecting heavy reliance on imported crude. The percentage of imported oil in total consumption is around 70 and 80 per cent, respectively, in China and India.

The latter will surpass China to become the fastest growing energy market by 2030, said India's Oil Minister Dharmendra Pradhan. "The energy and steel sectors will play important roles in driving India on the path of becoming a US\$5-trillion economy," the Minister added. While China and India remain the largest growth markets in volume terms, smaller south-east Asian economies are likely to outperform in percentage terms, as burgeoning demographics and rapid industrialisation accelerate their current growth trajectories.

“ Slightly elevated prices would entice investments into conventional projects.”

## 7. Washington-Tehran conflict

Iran's huge supply overhang (almost 5mn bpd on par with Iraq) could alter significantly the 'market balance'. Sanctions have cost Iran 90 per cent of its oil exports, and will continue to block a large portion of upstream potential off the market during the U.S. election year.

"Iran would have earned US\$200bn surplus income...if the country were not involved in an economic war," President Hassan Rohani said.

The EU is keen to forge a new nuclear deal with Tehran (albeit unlikely amid the present climate), which could mean 2.5mn bpd of Iranian crude hitting the market. The Instrument in Support of Trade Exchanges (INSTEX) devised by the EU to facilitate non-US dollar and non-SWIFT (the main international payment system) transactions without falling under U.S. sanctions has had little, if any, effect upon European purchases of Iranian oil during the past two years.

## Conclusion

Price forecasting is difficult even in best of times, since the oil market is subject to upside and downside risks. The latter include slippage or, worse, abandonment of OPEC+ curtailments, a breakdown of U.S.-China trade relations and thus damaging the global economy, larger-

## Global oil consumption by sector, 2020. Projected total: 101.0 (mn bpd)

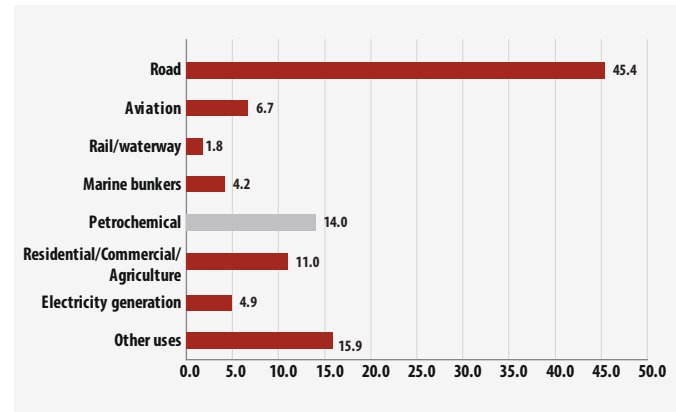

Source: OPEC World Oil Outlook 2019

## Crude oil price\* (five-year trend), US\$/barrel

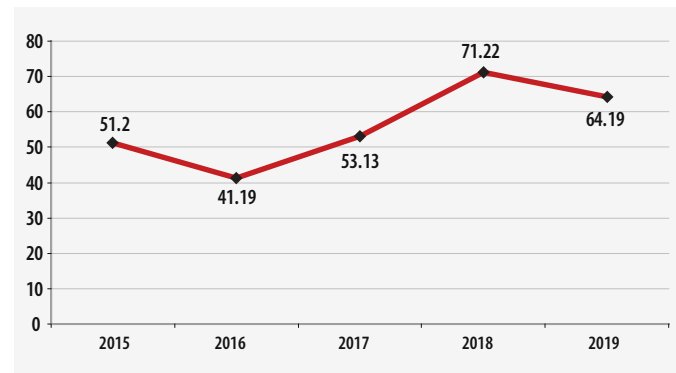

\*Brent spot average (global benchmark)

Sources: BP and OPEC databases

Note: In Dec 2019, Reuters surveyed 42 oil market analysts, who projected a combined average Brent price of US\$62.50 in 2020.

than-expected surge in non-OPEC supply, a stronger U.S. dollar that reduces oil offtake in importing countries, and possible downturn in Eurozone and Asia (principally China). As Ben van Beurden, Shell CEO put it, "The market is currently driven by sentiment rather than the real strong fundamentals of it."

Favourable scenarios include a quick/comprehensive end to the Washington-Beijing trade spat, further OPEC+cuts plus a slowdown in the U.S. shale boom, a pickup in global inventory restocking, sudden production outages in volatile regions (i.e. geopolitical premium) and massive fiscal stimulus in major oil consumers in the form of heavy infrastructure spending, as well as a recovery in vehicle sales. Discounting the 'fear premium' and factoring in 'market fundamentals', Brent crude should hold in the US\$60-65/barrel range in the coming months.

The IEA estimated that global upstream investment rose six per cent in nominal terms last year to US\$505bn, but the steep drop in oil prices (2015-17) that led energy majors to forgo capital intensive new projects still left the figure around US\$300bn lower than at the 2014 peak. Slightly elevated prices would help entice investments into conventional projects, including offshore, oil sands and Arctic plays, thereby mitigating the risk of a 'supply crunch' in the mid-2020s. The industry needs to double the number of approved conventional oil projects in order to meet future demand, urged the IEA. ■

# A Mediterranean energy hub

Egypt is on track to become a gas powerhouse for the Mediterranean region, with domestic production on the rise and first imports from Israel now flowing. Martin Clark reports.



Image Credit: Adobe Stock

*Eni's discovery of the giant offshore Zohr field has triggered a wave of new investment.*

**E**GYPT'S QUEST TO establish itself as a major Mediterranean gas hub is advancing at pace. As well as rising domestic reserves and output, mainly from the prolific offshore region, the country recently began imports of Israeli gas, which could be sold on to Europe and other markets within months.

Egypt re-established itself as a net gas exporter at the end of 2018 after almost a decade of running short. A big turning point was the 2015 discovery of the giant Zohr field in the Shorouk concession by Italy's Eni – the largest gas discovery ever made in Egypt and in the Mediterranean Sea. This field alone is estimated to contain 30 trillion cubic feet (tcf)

of natural gas, but triggered a wave of additional exploration and discoveries.

Eni holds a 50 per cent stake in the concession, alongside Rosneft (30 per cent), BP (10 per cent) and Mubadala Petroleum (10 per cent).

“What is encouraging is that more resources are being identified all the time.”

## Export hubs

This means the country's two long-established liquefied natural gas (LNG) facilities, that have been idled or running below capacity in recent years, can be used to boost exports. The Damietta LNG site has been dormant since 2013.

From January 2020, Israel is now supplying 85 billion cubic metres (bcm) of gas from its Leviathan and Tamar offshore fields over a 15-year period. Worth an estimated US\$19.5bn, the import deal is being handled by a private firm in Egypt, Dolphinus Holdings. It has been hailed as one of the most significant deals to have been signed by the two neighbours since a peace pact four decades ago. Israel's

Energy Minister Yuval Steinitz has called it “just the start” of cooperation.

### Pipeline potential

With Egypt's own gas volumes on the rise, there is scope for other exports too, via the Arab Gas Pipeline which extends into Jordan and on to Syria and Lebanon. Although Egypt currently only exports gas to Jordan through it, the pipeline was also once a conduit for export sales to Israel.

“Part of Cairo's strategy involves opening up new areas for exploration and potential development.”

Cairo is looking to position the country as a major energy hub between Africa, Europe and the Middle East. It is a strategy backed by strong and growing domestic production. According to the state-owned Egyptian Natural Gas Holding Company (EGAS), the country produced 2.52 tcf of gas in 2018/19. Some 58 per cent of this production comes from the Mediterranean, with a further 20 per cent each from the Western Desert and the Nile Delta, and the remainder from the Gulf of Suez and Sinai peninsula.

### Prime movers

What is encouraging for Egypt's energy planners is that more resources are being identified all the time, including oil.

Prime mover Eni unveiled its latest oil find at the tail end of last year, following an

appraisal well of the earlier Sidri South discovery, announced last July. Sidri South is estimated to contain about 200 million barrels of oil in place, although this is being reassessed in light of the new drilling. The new finds are located in the Abu Rudeis Sidri development lease, in the Gulf of Suez, with the Italian major declaring that it would push for rapid development.

Eni's current equity production is now around 350,000 barrels of oil equivalent per day, although it expects this to further grow within the year, thanks to the Zohr gas field and to the Baltim SW field ramp-up. Last August, Eni announced that Zohr gas production had reached 2.7 billion cubic feet (bcf) per day, but was expected to rise to a plateau rate of 3.2 bcf per day.

### Other investment

The success of Eni and the spectacular Zohr field also triggered a wave of new investment by other oil and gas majors as well as smaller firms.

This resulted in an upsurge in new discoveries and swelling reserves. According to data and analysis company GlobalData, EGPC led globally among companies in Q3 2019 with the highest number of oil and gas discoveries – four in total.

Change is also in the air, with some companies replacing older, existing names. Last year, Dubai-based Dragon Oil, owned by Emirates National Oil Company (ENOC), completed the purchase of BP's oil concessions in the Gulf of Suez, with plans to invest some US\$1 billion over five years to boost and extend production. Dragon's new partnership with EGPC in the Gulf of Suez Petroleum Company (GUPCO) aims to increase its combined production to 75,000 bpd of oil by 2021 from the current 60,000 bpd.

### New licensing

Part of Cairo's strategy involves opening up new areas for exploration and potential development. In December 2019, Egypt awarded exploration concessions in the Red Sea to Chevron (Block 1), Shell (Block 2) and Mubadala (Block 4) following a maiden international tender. The three blocks cover a total exploration area of around 10,000 sq km and come with a minimum investment spend of US\$326mn, the petroleum ministry said in a statement. Egypt had offered 10 blocks in the round across its maritime shelf area, which borders Saudi Arabia.

In January, Exxon Mobil announced that it had secured more than 1.7mn acres for exploration offshore in the North Marakia Offshore block, which is located approximately five miles offshore Egypt's northern coast in the Herodotus basin; and in the North East El Amriya Offshore block in the Nile Delta. Operations, including the acquisition of seismic data, are due to commence this year.

There are other initiatives to unlock potential elsewhere, deploying the latest technology to pinpoint reserves and draw in more investment.

That includes plans to acquire the world's highest resolution gravity imagery, eFTG (enhanced Full Tensor Gravity Gradiometry), within Egypt, by seismic and data experts TGS, with AustinBridgeporth. The first phase will survey the Upper Egypt region, but will be expanded to cover offshore areas as well.

“This high-resolution dataset will improve the geological understanding of the different play types in this highly prospective frontier area and provide the industry with essential subsurface data ahead of anticipated 2020 license rounds,” noted Kristian Johansen, chief executive of TGS. ■

## EGYPS 2020 - capitalising on opportunities in North Africa and the Mediterranean

EGYPS 2020, WHICH takes place from 11-13 February at the Egypt International Exhibition Center, Cairo, will provide an important platform for industry professionals to gain insights into the upcoming oil and gas opportunities in North Africa and the Mediterranean, to engage in dialogue, create partnerships and do business. It is expected to attract 30,000 attendees from local and international businesses and 450 exhibiting companies, bringing together government representatives, project owners, NOCs, IOCs, international service providers, EPCs, consultants and financiers to address the evolving opportunities in the North African and Mediterranean energy arena.

The conference features five dedicated conference tracks, hosting more than 230 expert speakers and attracting 1,600+ conference delegates. These include the strategic conference, technical conference, finance and investment



HE Tarek El Molla, Egypt's Minister of Petroleum and Mineral Resources, will address the conference.

conference, HSE in Energy conference and awards, and Women in Energy conference and awards, in addition to the CEO and Strategic roundtables.

Speakers include His Excellency Tarek El Molla, Minister of Petroleum and Mineral Resources Arab Republic of Egypt; His Excellency Santiago Mba Eneme Nsuga, Secretary of State for Mines and Hydrocarbons, Equatorial Guinea; His Excellency Abdourahmane Cissé, Minister of Petroleum, Energy and Renewable Energy, Cote d'Ivoire; His Excellency Mohammad Barkindo, Secretary General, Organization of the Petroleum Exporting Countries (OPEC), Patrick Pouyanné, chairman and CEO Total Group, and Bob Dudley, CEO BP.

For further information see the website at [www.egypt.com](http://www.egypt.com).

# Turning ideas into products

Daniel Martinez, Reflex Marine's design and project engineer, discusses the importance the company attaches to innovation and continual improvement.

**For Reflex Marine it's been another year of brave new projects and changing perspectives in the offshore industries. From your perspective as project engineer, why is innovation an important part of the business?**

At Reflex Marine we see innovation as an attitude, more than just an activity we happen to conduct. I think this is important, because it puts our mindset in a position of permanent curiosity about industry challenges. This attitude not only allows us to come up with ideas that can, eventually, be turned into new products or existing product upgrades; it also means as a company we continue to contribute to increasing safety standards in the industry while delivering exciting projects. Personally, as an engineer, I've always found it to be both rewarding and enjoyable.

As an innovation company, it is certainly key to our brand and position in the market. However, by looking for needs and problems to solve, not only do we find opportunities for developing new products, it also allows us to maintain a close relationship with clients and partners by seeking their feedback and being able to deliver more value to them by applying our experience and skills to improve their operations.

In addition to developing new products, we continuously look at ways of improving existing products and procedures to ensure we stay up-to-date with industry and technology developments. For instance, we have recently revisited our current product range to address specific conditions which are challenging for crane transfer. Based on our evaluation, we developed the new FROG-XT6-P, which is now ready to be launched onto the market.

**Could you give an example of how the inspiration for a new product comes about?**

We are proud of being able to establish strong collaborative relationships with other businesses, not only in our supply chain but also with prospective and existing clients that may have particular needs not directly addressed by our product portfolio.

A good example of this is STORM-WORK, developed in partnership with Seaway Heavy Lifting: Seaway had very particular safety requirements for their operations involving work baskets that were not met by the products available in the market at the time. At Reflex Marine, we took this opportunity to use our expertise in crane access operations and design to develop a new product that could cover our partner's needs, but also be used to increase safety standards in similar operations across the globe.

This experience led us to identify other challenges, this time around the cargo transfer operations. We soon started to work on a new product concept to make offshore cargo transfer safer and more efficient, which is now in its final phase of development and being tested by our partners.

“ We continuously look at ways of improving existing products and procedures.”

**Where once the offshore industry was almost entirely oil and gas, has the growth of offshore renewables changed the requirements coming from your clients?**

Absolutely! While the oil and gas industry has been the main driver of offshore activities for several decades, their solutions aren't appropriate for some of the problems faced in other sectors. In fact, the cargo container concept is a clear example of how the offshore wind industry had needs that had not been met by existing offshore oil and gas solutions, mainly due to the scale of both vessels and cargo, as well as the nature of the operations.

We have been very keen to develop our business into the offshore wind industry, as we feel we have valuable experience and knowledge of offshore access and transfer that can benefit the renewables sector by



Image Credit: Reflex Marine

**Daniel Martinez, design and product engineer, Reflex Marine.**

making their operations safer and more efficient.

Specifically, crane transfer of personnel for offshore wind turbines is something we have been advocating for over the past years, as crew transfers from vessels to the transition pieces currently rely very heavily on human factors, which make the operation less predictable and, therefore, less safe.

Luckily, there are now operators that are looking at crane transfer as a serious access solution for new wind farms. In fact, we are working on a small crew transfer carrier for a European operator who is interested in trialling this method on wind turbines that will be commissioned this year. This will also serve as a demonstration to other operators, and we hope we will be able to change the perception and mentality around crane access in the wind sector in a similar way as we did in the oil and gas industry in the North Sea almost 20 years ago.

**Why do you think that continuously improving existing products is important?**

We always strive for the highest standards of safety in our products, but we are aware that there is room for improvement in many areas, such as simplifying the maintenance of the products, incorporating new materials, or simply adapting them to newer industry requirements. It's key to remember that

products which look good on the drawing board don't always fit with how they're going to be used in the real world! The design must incorporate ergonomics for comfort of the users as well as procedures that ensure efficiency of use and ease of ownership.

In this regard, we are very conscious we must not become complacent, and we are always looking for better and more sustainable materials, improved ergonomics and designs, and ways to build products in a more cost-effective way. In the same way, we have to understand what's driving our clients, and the growing awareness of the full lifecycle environmental impact of a product is an important factor which we have to take into account.

“ Our knowledge and interest in new technologies are key to finding ways in which we can add value.”

Our knowledge and interest in new technologies are key to finding ways in which we can add value to the end-user and deliver the best product we can, whether through improving the ownership experience, reducing the costs, or adding safety features.

**You are now introducing a redesigned product called FROG-XT6-P. What brought about the change to the original concept?**

As part of our innovation focus, we identified operations conducted in particular regions of the world that could benefit from increased performance while still providing high-volume transfer capacity.

While the original FROG-XT6 capsule has performed extraordinarily well, and continues to do so, we acknowledged that the safety and performance envelopes could be improved to add value to clients who use the FROG as their main offshore access solution in very challenging weather conditions.

The new concept achieves this while maintaining the familiarity with the current product range, hence facilitating its use and inspection. One of the goals of our design process was to maintain a high level of common parts across the FROG-XT range, so that existing clients moving to the new design could transition without having to resupply replacement parts stocks, or retrain crews used to their existing carriers. We feel that we managed to achieve all of the design goals while maintaining a price level in line with our existing products, keeping in mind that cost-efficiency plays an important part in today's volatile offshore energy markets. ■



Image Credit: Reflex Marine

*Reflex Marine strives for the highest safety standards in its products.*



Image Credit: Reflex Marine

*The redesigned FROG-XT6-P will provide additional safety and performance benefits while maintaining cost efficiency.*

# Prioritising a low carbon future

Jan Zschommler, area manager Middle East, DNV GL – Oil & Gas, discusses the findings of the company’s latest report, which assesses industry sentiment and priorities for the year ahead.

**N**EW RESEARCH PUBLISHED by DNV GL reveals that while optimism for growth in the Middle East and North Africa’s (MENA) oil and gas sector has weakened for the year ahead, the region is in a stronger position than the global average. This comes amid continued uncertainty around the oil price and increasing concerns on global economic conditions – the top barriers to growth reported by the respondents. Further, the Middle East in particular, has seen heightened levels of regional tensions in late 2019. Continuing into 2020, this adds uncertainties for a local oil and gas industry dependent on undisturbed export routes to global markets.

Nearly three-quarters (71 per cent) of senior oil and gas professionals in MENA are confident for industry growth in 2020, down 12 percentage points from 2019 but higher than 66 per cent globally. While this is still a strong majority and confirms the newfound resilience to lower prices and volatile markets from last year, it shows doubt is creeping back into the industry’s psyche (Figure 1).

*New Directions, Complex Choices: The outlook for the oil and gas industry in 2020* is based on a survey of more than 1,000 senior professionals from across the oil and gas value chain. Now in its 10th year, DNV GL’s research assesses industry sentiment, confidence, and priorities, and provides expert analysis of the key challenges and opportunities for the year ahead.

## Main report findings

- More than half (54 per cent) say their companies would still achieve acceptable profits if the oil price were to average less than US\$50 per barrel this year (46 per cent globally)
- In line with global predictions, nearly three quarters (73 per cent) expect to increase or maintain investment in decarbonisation, rising sharply from 61 per cent in 2019
- Specifically, the industry’s intentions to increase investment in or develop offshore wind portfolios has rocketed in a year – up

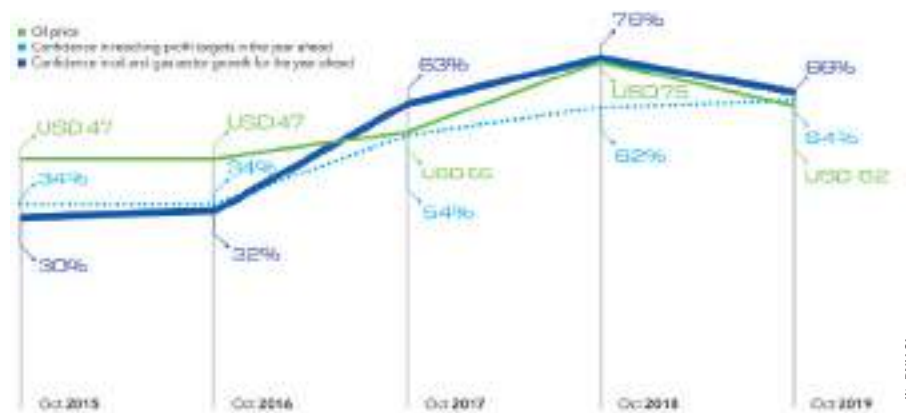

Figure 1: Oil price vs. industry confidence.

from 22 per cent in 2019 to 54 per cent. While supplier-driven inflation stabilises in MENA (47 per cent), it is seven percentage points higher than global opinion (40 per cent), impacting costs.

“ Nearly three quarters expect to increase or maintain investment in decarbonisation.”

Despite persistent uncertainty, growing complexity, and new risks, we also see an industry taking bold decisions, building greater efficiencies and rising to long-term challenges as the world pivots towards a lower carbon energy future. The MENA region is no exception as it enters the new decade with a full agenda.

Organisations across the value chain face the pressure of several evolving threats and opportunities, while navigating current market volatility. The report asserts that most companies must work to balance short-term

tactics with decarbonisation and business transformation to ensure long-term competitiveness.

## Surplus supply impact

The report outlines several developments and incidents in 2019 which may have affected industry sentiment in MENA for the start of the 2020s. Robust supply capacity was maintained despite severe limitations on several traditional sources. For example, the US renewed sanctions on Iran; an economic crisis hit Venezuela; unrest continued in Libya; and Russia and OPEC countries cut production. Even shock events, such as the drone attacks on Saudi Aramco’s largest refinery, didn’t dent the oil price as much as was feared.

Another factor is the significant spare capacity of the OPEC group and co-operating nations (i.e. the OPEC+ group of oil-producing countries). In December 2019, the alliance agreed to cut supplies by 1.7m bpd during the first quarter of 2020, which prompted a modest increase in the oil price.

With a high chance of oil and gas overabundance on world markets in 2020, many oil and gas companies would welcome

Image Credit: DNV GL



Figure 2: Percentage of respondents who agree that their organisation should decarbonise faster, by region.

a surge in economic growth to stimulate demand, soak up surpluses, and support higher prices.

### The capital conundrum

Over the next 12 months, more than half (55 per cent) of MENA respondents believe that more large, capital-intensive projects will be approved this year compared to 2019 – more optimistic than the global average of 46 per cent.

Of those questioned, more expect to see capex reduced further in MENA compared to last year (18 per cent versus 11 per cent) while plans to raise capex have stalled, as is the case globally.

“Leaders, experts and innovators across the region must firmly set their sights on lowering carbon footprint.”

Although capital may not flow as freely into large oil and gas projects in 2020, companies operating across the industry's value chain expect to boost investment this year in areas that will allow them to forge a permanent position in the energy transition. Those questioned expect increased investment in renewable energy projects – for example, this has doubled from 23 per cent to 47 per cent in a year.

While persistent uncertainty, growing complexity and new risks are inherent in the sector, the survey results reveal that companies in MENA are making bold decisions, building greater efficiencies and rising to long-term challenges as the world pivots towards a lower carbon energy future.

### Cost control and digital demands

Cost efficiency will be the top priority for more than two-fifths of MENA's senior oil and gas professionals (41 per cent), up from 26 per cent a year ago. Like its industry counterparts, eight out of ten (83 per cent)

respondents believe the industry needs to develop new operating models to achieve further cost efficiencies, recognising the fact that much of the more obvious cost-cutting has already taken place following the 2014 oil price crash.

Interestingly, the study captures a growing trend of cost efficiency measures becoming permanent changes across MENA businesses, up from 59 per cent two years ago to 72 per cent. The impetus to standardise tools and processes to curtail costs has also risen substantially, up from 62 per cent to 80 per cent for the year ahead.

A huge majority of MENA respondents (96 per cent versus 92 per cent globally) expect their organisation to increase or maintain spending on digitalisation in 2020. The survey revealed that those who believe their organisation is an industry leader in digitalisation are more confident in their company's prospects, more resilient to volatility in the oil price, and are pursuing greater investment in the energy transition.

Cyber security concerns have risen significantly in MENA, with a much larger slice of spending forecast for the year ahead – more so than globally. Safely controlling and averting cyber incidents is a high priority for 35 per cent of those questioned, nearly quadrupling last year's figure of nine per cent.

### Unprecedented vision and ambitions for the 2020s energy mix

Oil and gas will be needed in the energy mix for decades to come – forecast to account for 46 per cent of the world's energy mix in 2050 compared with 54 per cent today, according to DNV GL's 2019 Energy Transition Outlook (<https://eto.dnvgl.com/2019/index.html>).

However, from the oil and gas Industry Outlook survey more than half (55 per cent) expect their organisation to actively adapt to a less carbon-intensive energy mix in the year ahead. Regulations were reported by 46 per cent of MENA respondents as the most important driver to decarbonise operations.

Based on population and GDP growth,

there is a significant rise in electricity demand expected in the MENA region, and DNV GL forecasts that gas-based generation which will increasingly be complemented by renewable power. For instance, the survey found there is a greater focus on maintaining or increasing investment in photovoltaic (PV) solar (71 per cent) and solar thermal (57 per cent) in 2020.

It is anticipated that a developing renewable industry in MENA can provide much-needed diversification of local employment opportunities and viewed favourably by local governments. DNV GL is supporting several renewable energy projects in wind, solar and energy storage throughout the region.

It is clear from the survey that more and more people in the MENA sector are realising that they cannot sit and wait for the perfect solution to catapult them to a completely decarbonised energy system. Figure 2 validates a resounding call by 70 per cent of MENA respondents for their business to accelerate the drive to decarbonise, by far the loudest declaration compared to 49 per cent in Europe and just 25 per cent in North America.

Such a spur to action means leaders, experts and innovators across the region must firmly set their sights and spending plans on lowering carbon footprint and investigate safe and secure means to clean up and reduce the cost of oil and gas operations in the future.

*Jan Zschommler has more than 20 years of comprehensive technical background and experience in the fields of process engineering and project management, as well as commissioning and start-up of plants in the oil & gas and petrochemical industry. He has also worked with onshore and offshore projects for the oil & gas and offshore wind industries. Based in Abu Dhabi, Zschommler leads a team of more than 60 technical experts working in multiple sections and offices throughout the Middle East. ■*

Download a complimentary copy of *New Directions, Complex Choices* from [dnvgl.com/industryoutlook2020](http://dnvgl.com/industryoutlook2020)

# Gas investments on the decline?

A report by the Arab Petroleum Investments Corporation (APICORP) forecasts a US\$70bn decrease in MENA gas sector investments over the next five years. Amr Bakkar reports.

**A**CCORDING TO APICORP'S *MENA Gas Investment Outlook 2019-2023*, published in December 2019, a year-on-year decline of US\$70bn (-27 per cent) in the outlook for both committed and planned gas investments is expected over the next five years. This can be attributed to a combination of high global gas output, slowing regional demand and, in some countries, an inability to access finance. In contrast, investments in petrochemicals for 2019-2023 show a 50 per cent y-o-y increase from the previous 2018-2022 outlook as the region enters the next level of supply integration and further monetisation of hydrocarbon production.

APICORP's research indicates that the total committed and planned investments fell, largely due to Saudi Arabia successfully commissioning major projects, and reduced prospects for Iran.

"Committed projects declined by 17 per cent, driven by a more than US\$11bn and US\$5bn drop in Iran and Egypt, respectively. Out of the nine countries that had committed upstream investments in the 2018 outlook, seven of them saw a y-o-y decline, including Iran, which saw its share of projects under execution fall by 77 per cent. Libya, Iraq and the United Arab Emirates (UAE), on the other hand, are among the few countries witnessing an increase."

On the upstream side, the UAE announced a 1.6 trillion cubic metres (tcm) addition to its conventional gas reserves in November 2019, catapulting it to sixth place globally in terms of gas reserves. It also became the first country in the region to list unconventional gas reserves of 4.5 tcm.

With countries such as Iran and Algeria are struggling to attract private sector investment, the risks on upstream developments materialising will continue to be high, the report says. Low gas prices are urging investors to follow a wait-and-see approach.

In terms of planned investments, two-thirds of the MENA countries will experience lower investments in their upstream gas sectors. "Even though reforms have contributed to the reduction in energy subsidies and improved energy efficiency and renewables programmes, there is still a risk of under-investment in upstream gas. A fair number of the greenfield power projects – in Saudi Arabia (12GW) and Egypt (9GW) – will undoubtedly require additional gas supplies. Major upsides may possibly come from Qatar, where tenders for additional LNG processing trains – estimated at US\$15bn – have recently been issued," the reports says.

In terms of consumption, the report states that there is a slight growth of gas consumption in some MENA countries, such as Egypt, domestic annual gas consumption is estimated at 72 billion cubic metres (bcm) in 2020 and 92 bcm in 2021. Consumption is expected to grow at an average rate of four per cent per annum over the next

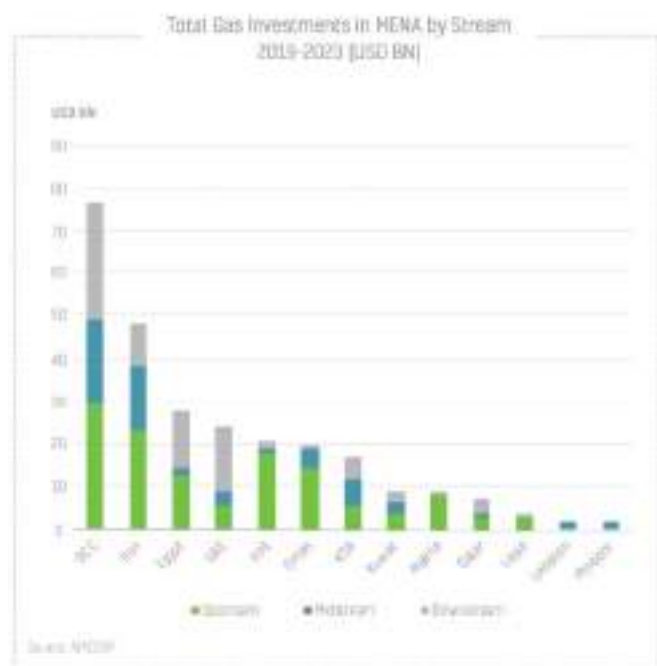

Image Credit: APICORP

five years as a result of power generation, gas exports and industrial development.

Saudi Arabia's gas demand is expected to grow at an annual average rate of 1.8 per cent to 2024, a deceleration on historical growth, with medium term consumption largely driven by power generation and industrial activities.

Saudi Arabia has gone from gas tightness to excess gas, and has ambitious plans to increase its gas production capability further, from 127 bcm in 2017 to 235 bcm by 2026. Gas demand growth however is unlikely to place significant pressure on supply in light of the competing fuels in power generation.

The report states, "In the UAE, industrial needs will become the main driver for gas consumption over the coming years – especially in the petrochemicals sector. Gas demand for power generation is expected to slow to less than one per cent per annum to 2024 compared to almost six per cent over the past six years, primarily due to the delayed commissioning of nuclear power units (5.6 GW) at Barakah and several solar power projects gradually coming online."

Over the past six years, Algeria's gas exports have been affected by declining production, while domestic consumption continued to grow at a high rate of five per cent. This has caused pressure on government finances, with hydrocarbons accounting for 95 per cent of total export revenue. ■

“ There is still a risk of under-investment in upstream gas.”



# HEAVYWEIGHT LIFTING WITH EASE



Find us on  
**facebook**  
/dresstamachines

More  
about  
Dresssta



## Check out our industry renowned Dozers & Pipelayers



8 models of dozers  
from 78 to 536 hp



3 models of side-boom pipelayers  
from 33 to 100 tons lifting capacity



Service & Parts support  
from a network of World-class  
dealers across Middle East

▶▶▶ More on [www.dresssta.com](http://www.dresssta.com)

✉ [info@dresssta.com](mailto:info@dresssta.com)

 **DRESSSTA**  
ENGINEERED FOR YOUR BUSINESS

# Advances in gas detection

Technology is driving safety improvements in gas detection, delivering greater connectivity, portability and accuracy.

**G**AS DETECTION HAS always been fundamental to safety across the energy field. This is no different today, though technology has made it easier with the arrival of portable, internet-enabled and other devices.

Major players in the global wireless gas detection space include the likes of Siemens, Honeywell and Thales. Much of the innovation in recent times has focused on improving safety for operatives, while also delivering high-accuracy data.

Agilent Technologies recently introduced its new micro gas chromatograph – the Agilent 990 Micro GC system – intended to monitor the safe distribution, calorific valuation, and odourant level in natural gas. With double the battery life of previous models, the portable system provides over eight hours of remote operation for many applications. An optional mobile browser interface allows remote connectivity with other devices such as laptops or tablets, and allows hands-free, unattended operation in places that are more difficult, or potentially less safe, for humans to access.

Compact and rugged, it delivers laboratory-quality data whenever and wherever it is needed, according to Agilent's Eric Denoyer. "This not only improves scientific and business outcomes for our customers but also helps improve the quality of life in the communities we serve," he said.

UK-based Crowcon, a part of the Halma group, recently released a new series of customisable gas detection controllers which, it says, offer great versatility. The modular design of the new GM series controllers means each can be built to the user's specification, Crowcon said in a statement.

"This includes the choice of input and output types and channel quantity, as well as mounting type and power supply options. The controllers can also be upgraded by adding additional functionality at any time after the initial installation."

There are three models in the new range: the GM16 provides up to 16 channels, GM64 has 64-channel capacity and the GM128 offers up to 128 channels.



*Technology developments and increased connectivity are helping to keep workers safe.*

Image Credit: Safety.io

"With the GM controller series targeting hazardous gas monitoring applications, the easy-to-use navigation and configuration features improve safety by minimising the time users need to spend in potentially hazardous locations," Crowcon said.

**“ Much of the innovation has focused on improving safety for operatives ”**

The controllers can be specified for traditional 4-20mA analogue communications if that is what the user already works with. However, they can also be supplied with digital addressable communications, which allows multiple fixed detectors to be linked together on a single communication loop. "This drastically reduces the cabling and labour costs, as well as the time taken to complete the overall system installation."

It added, "Furthermore, the ability to view data and configure the controller remotely improves safety even further. All data and functions can be accessed from the controller

front panel or the information can be fed to a remote fixed computer screen or mobile device with internet capability."

## Enhanced gas detection offering

Honeywell has enhanced its gas detection offering with the acquisition of Rebellion Photonics, a Houston-based provider of innovative, intelligent, visual gas monitoring solutions with an aim to maximise safety, operational performance, emissions mitigation and compliance in the oil and gas, petrochemical and power industries.

Rebellion Photonics offers a real-time monitoring platform that visually identifies and quantifies gas releases to quickly detect and analyse leaks and keep workers safe. The intelligent monitoring system incorporates a sophisticated AI-driven software platform that automatically alerts plant operators if a gas leak, fire or security issue is detected and provides detailed analytics.

The company's technology offers a cost-effective monitoring solution by reducing the need to install, maintain and calibrate sensors throughout a site. Its customers include some of the world's largest oil and gas, petrochemical and power companies, and its solutions are deployed at refineries, oil rigs, offshore platforms, pipelines and power plants.

**BAUER  
KOMPRESSOREN**

Quality. Our DNA

## **UNICUS® 4i**

The **NEW** Standard for  
**Stationary High-Pressure  
Breathing-Air Compressors**



- › **BAUER Compressors, Inc.** is known as the leader in high pressure breathing air compressor systems and components. Once again BAUER has proven that by creating the most technologically advanced compressor system in the industry. **UNICUS 4i** is an "All-In-One" compressor package which centralizes all high-pressure breathing air system components into one appliance type package.
- › Imagine an operator interface similar to your smart phone. An **Interactive Touch Screen, BAUER Gas-Tek for Gas Monitoring System, RFID Reader & Lab on Local** that provides Real-Time air Sampling & Testing (offered as options) all in a tap of a screen.

**Website: [www.bauer-kompressoren.de](http://www.bauer-kompressoren.de)**

Email: [sales@bauer-kompressoren.ae](mailto:sales@bauer-kompressoren.ae)

“To rapidly respond to a gas leak and keep their facilities safe, oil and gas, petrochemical and power companies are deploying Rebellion Photonics’ next-generation visual monitoring technology powered by machine learning,” said John Waldron, president and CEO of Honeywell Safety and Productivity Solutions.

Robert Kester, CEO of Rebellion Photonics, said, “Automated visual monitoring is the future of gas leak detection. Combining our products with Honeywell’s platform will make this the new industry standard for safety and environmental monitoring globally.”

Rebellion Photonics provides a patented gas cloud imaging system that incorporates cameras and proprietary hyperspectral imaging technology to pinpoint the source of a leak and measure the volume and concentration of gases. The company also provides real-time fire detection and intrusion and surveillance monitoring solutions to keep plants and facilities safe.

## Ensuring compliance

Another major player is MSA, whose Safety io division was created to pioneer technology advancements. It has developed Safety io

Grid Fleet Manager, a cloud-based platform for managing the health of fixed and portable gas detection devices.

“One of the major goals was to ensure that information delivery was carefully prioritised: that customers received the critical information they needed when most relevant,” the company says. “It’s also about recognising when data is useful; whilst gas levels in an area may not reach compliance thresholds, the detection of a low-level anomaly can indicate whether investigative work may be warranted.”

Safety io’s Grid Fleet Manager – software service for managing fleets of portable gas detectors – helps to ensure compliance through a proactive safety approach. It simplifies the management of the fleet of portable gas detection, by gathering and compiling data automatically, as devices are returned and docked after use and bump tested or calibrated before use. It focuses on prioritising the most important information, prominently highlighting when and where urgent action is required. An intuitive fleet dashboard shows top-level, prioritised metrics and alerts, each of which can be expanded at a click to reveal granular-level detail on any

device or event. Fleet Manager provides alerts on sensors that require attention so that the equipment at risk can either be maintained or replaced before it fails.

Safety managers are able to detect when, where and by whom a device was last used, when it was last tested or checked, and whether any further tests are needed.

As well as providing vital early warnings about leaks, today’s advanced, portable gas detectors also gather and store invaluable data – recording critical information both about incidents and also the working practices of operatives. This information, held locally on each device, can be downloaded when the device is docked and – ideally – properly analysed for insights. By constantly pulling and storing data from all devices, Fleet Manager provides valuable insights to safety managers on non-safe behaviours.

The system can also help to achieve compliant operational practices. Whenever a gas detector issues an alarm, operatives must follow strict Standard Operating Procedures. If these are ignored, these occurrences are recorded and highlighted, allowing safety managers to identify those posing a risk, and swiftly move to re-educate or retrain them. ■

## The Milestones .... Steering the growth

**Business:**

- Topline Growth > 40 % over last year. CAGR of > 40% for three years, in a row.
- Completed **Single largest order from Africa** of approx. USD 5 Mn, (approx.. 10,000 valves), in 9 months.
- **Repeat orders for past 5 years for Russian projects to NipiGas, Sibur** involving **Cryo Valves, TR/CU** compliances. (Total valves supplied >12000).
- **Overdue orders < 5%**, showing our on-time performance.
- Trusted supplier to major end users like **Basra Gas (Iraq), Dangote Group (Nigeria), Gazprom / NipiGas/ Sibur (Russia), KOC/JO (Kuwait), Petronas/MLNG (Malaysia), Petrobras (Brazil) OGC/Orpic (Oman) & Sasol (South Africa)**

**Unique achievements:**

- Supplied 2 Nos 54" Gate valves to an Indian Oil Major in 9 weeks.
- Supplied 4 Nos 36" & 42" Gate Valves for a Refinery with world's largest linear actuator ever manufactured.
- Received SIL3 certification; Now offering ESDV (Emergency Shutdown Valves)

**Invested USD 5 Mn in infrastructure :**

- Upgraded Foundry capacity with **addition of furnace of 3 Ton capacity** in addition to earlier 1.5 Ton and 1 Ton
- Commissioned advanced Valve Machining centre and 3 large CNC & VTLs
- Installed latest automated Paint booth & Test Bay for large sized valves
- Enhanced R&D center with latest equipments

• Gate • Globe • Check • Ball • Pressure Seal • Cryogenic • Special application valves

Oswal's Valves are the result of Innovative engineering & state-of-the art manufacturing. It embodies all the quality, Performance, value and safety features required for critical applications.

**SIZE : ½" - 72" CLASS : 150# to 2500#**



**OSWAL**  
INDUSTRIES LIMITED  
[www.oswalvalves.com](http://www.oswalvalves.com)

Italy UAE Kuwait Japan Korea Netherlands Spain USA

## Renewing the focus on health and prevention

Image Credit: Adobe Stock



The Forum will have a renewed focus on health and prevention.

THE HIGHLY ACCLAIMED Kuwait Health, Safety & Environment Forum returns to Kuwait from 2-3 March 2020. Taking place at the Jumeirah Messilah Beach Hotel & Spa, Kuwait City, the Forum will bring together health and safety professionals, government regulators, policy makers and solutions providers to explore topical health, safety and environment issues.

Held under the patronage of Kuwait's Ministry of Health, and in association with Kuwait National Guard and Kuwait Fire Services, the Forum, which builds on the success of the highly acclaimed inaugural event held in September 2018, will provide a platform for the sharing of insights, expertise and best practice across the spectrum of health and prevention, safety and security, environment, risk management and technology.

Despite rapid advances in the health and safety sector, Kuwait faces a range of occupational health challenges such as reducing environmental hazards, improving the effectiveness of health policies, addressing communication issues and promoting healthy lifestyles and behaviours that will encourage a safer work environment and advance worker wellbeing.

There is also a big push on sustainable healthcare, tying in with the unified Gulf Health Strategy and the UN Sustainable Development Goals (SDGs), to raise standards of health and wellbeing throughout the country.

Dr Ahmed Haji, senior doctor, Petrochemical Industries Company KSC (PIC), commented that there is an increasing level of awareness in Kuwait of the benefits of actively promoting worker health and wellbeing, particularly at the decision-maker level in oil sector companies.

"Line management commitment is a critical requirement for ensuring high standards of occupational health," he said. "PIC has accomplished several Six Sigma projects in occupational health, and we have a well-established and successful behavioural-based safety programme. Sharing expertise and best practice raises all standards and procedures."

Subjects addressed will include health promotion; sustainable healthcare as a way forward to achieve the unified Gulf Health Strategy; improving competency and safety in high rise construction sites; protecting workers with 3D modelling; driving safety; safety implementation among culturally diversified employees; leadership and safety culture; mitigating risks in hostile environments; IoT for monitoring potential workplace hazards; health and safety communications; the effects of greenhouse gases on health and environment; and preventing environmental contamination by hydrocarbons.

Speakers include Dr Duaa Alkhaledi, director, Occupational Health Department, Ministry of Health, Kuwait; Nasser AlBuhairi, chief security officer and head of Emergency Coordination Unit, Kuwait Oil Company; Dr Ghaida Mubarak Al-Shoraian, senior general practitioner, Kuwait National Petroleum Company; Qusai Al Shatti, acting director-general, Central Agency for Information Technology (CAIT); Dr Muhammad Alamgir, HSE manager, Petrofac, Kuwait; Dr Ahmed Haji, senior doctor, Petrochemical Industries Company KSC; and Jason Woods, Middle East & India representative for the International Powered Access Federation (IPAF).

For further information and to register, see the website at [www.hse-forum.com](http://www.hse-forum.com).

**Bolts • Nuts • Studs**  
**Sockets • Washers**  
**Bent Bolts • Specials**



**Industrial Bolting**



**24-7 Emergency Service**

**Special Metals and Alloys**  
**Over 150 Material Grades**  
**Over 25 Coatings and Platings**  
**Over 300 Machines**  
**10,000 Ton Inventory**  
**Future Stock Programs**  
**We Service All Quantities**  
**Serving Distributors Worldwide**

[www.GoASF.com](http://www.GoASF.com)

[info@GoASF.com](mailto:info@GoASF.com)

# Next-gen isolation gasket to address corrosion challenges

Garlock Pipeline Technologies (GPT) sees enhanced prospects for its business in the Middle East, following the launch at ADIPEC of its next generation, fully coated isolation gasket EVOLUTION®, which is able to withstand high temperature, high pressure environments and is resistant to aggressive media such as H<sub>2</sub>S. *Oil Review Middle East* spoke to Robert Colton, the company's business manager & director EMEA at ADIPEC.

**T**HE MIDDLE EAST is historically an important region for GPT, the leading global manufacturer of critical pipeline sealing and electrical isolation products.

"We're approved by all the end users in the region and have been very active here for more than 30 years," says Colton. "We work on major projects throughout the Middle East, a lot of work for Aramco and particularly with ADNOC here in Abu Dhabi on major offshore platforms. We seal flanged joint connections and electrically isolate those offshore as well as onshore, we get involved in upstream, midstream and downstream, and our products go into refineries as well as flowlines. Our product line is instrumental in preventing corrosion and maintaining asset integrity.

"Importantly, our technology is fire safe, so if there is a fire in a plant, tank farm or refinery, the flanged joints in which our products are located and fitted will keep their integrity and not release any burning media."

Colton is positive about prospects for the new product line given the aggressive media which pipelines and isolating gaskets are increasingly exposed to, and in many cases, the inability of GRE material, traditionally used for electrically isolating flanges on offshore platforms, to withstand such harsh conditions.

"Preventing galvanic corrosion is a really big issue these days, particularly as technology is allowing operators to drill deeper to obtain the reserves from below ground and offshore and enhanced recovery techniques are becoming the norm," he explains. "But the deeper you drill, the more sour the media can be, with very high concentrations of hydrogen sulphide, which is very corrosive for metals and a real danger in pipelines, as well as being a silent killer. We are also seeing mixtures of carbon dioxide and different gases, along with higher temperatures and pressures creating a cocktail



Robert Colton, business manager and director EMEA, GPT.

Image Credit: GPT

of extremely toxic and corrosive media.

"So we really needed to innovate and bring something new into the market," he continues. "End users such as Saudi Aramco were asking us to bring new technology to help them develop further and allow their assets to be safe, and for their human assets to be safe as well. It's not just a case of preventing corrosion but ensuring safety, which is paramount with many end users. So we needed to come up with a product that would meet the demands and changes we're seeing in oil and gas."

And so, following extensive consultation with end-users, which included sending out

thousands of questionnaires, meeting with technical bodies and conducting advisory board meetings with end users EVOLUTION, a fully encapsulated isolation gasket, was born.

## Positive reception

"The product line is still in its infancy, but the whole concept of a coated flange isolation kit has been very well received," says Colton. Chemical exposure testing of the abrasion and impact resistant proprietary coating in H<sub>2</sub>S, steam and CO<sub>2</sub> prove that the material is a significant technological leap versus traditional GRE-type isolation gaskets.

"The product is currently with a number of end users for approval. It's the most tested product we have ever produced, designed to bring pipelines into emission compliance, fire safe, and able to meet the challenges of both hazardous and corrosive media. It's ticked every box and attracted a lot of interest here at ADIPEC."

Colton adds that while the company has

“ Preventing galvanic corrosion is a really big issue these days.”

EVOLUTION is the next step in gasket technology.



Image Credit: GPT



Image Credit : GPT

The fully encapsulated coating is resistant to H2S, steam CO and CO2.

due to dissimilar metals, even in refining, as well as joining flanges of dissimilar stylesl.

“And with end users now under pressure to reduce emissions and improve leakage rates, we are helping with this product, which is the tightest sealing gasket we’ve ever produced.” EVOLUTION has the lowest emission values for any isolation gasket available in the market today, according to the company.

But it doesn’t end there; there is a constant drive to innovate. “If we don’t innovate, we will stand still,” stresses Colton. “As a company, we invest heavily in research and development and truly understand the value of innovation, so we can continue to develop products that meet the demands of oil and gas. The product line we’ve just launched at ADIPEC is really in a Phase One stage. We are looking at developing it into a smart technology, putting in sensors to monitor any leakage or any movement, or any loss of bolt load. That is something that is definitely on the agenda as we move forward. “We’re also looking at RFID technologies, so that anyone scanning the product would know who installed it, when it was installed, the media and temperature etc. and so that a flange joint could be monitored remotely from a monitoring station. The feedback from end users is that this is valuable to them. A lot of companies are using drone technologies now to inspect pipelines.” Staying close to customers and listening to their concerns is a critical factor in identifying the future direction of innovation, he adds. ■

historically not been a major player downstream, the fact that the new product is rated to withstand temperatures of up to 260 degrees, means there is scope for further use in refineries. “We’re able to prevent galvanic corrosion



# Bell Energy Services UK Ltd

## ASSET INTEGRITY MANAGEMENT SERVICES

Efficiency and asset performance assurance are of prime importance to ensure supply of Oil and Gas during current economic conditions. Bell Energy offers competitive, safe & innovative services for asset integrity, reliability, risk and performance management.

<ul style="list-style-type: none"> <li>✓ Conformity Assessment</li> <li>✓ Inspection and Testing</li> <li>✓ Well Integrity Management</li> <li>✓ Cathodic Protection</li> <li>✓ Vendor Inspection &amp; Expediting Services</li> <li>✓ Internal &amp; External Corrosion Assessment</li> </ul>	<ul style="list-style-type: none"> <li>✓ Reliability Centered Maintenance (RCM)</li> <li>✓ Certification Services</li> <li>✓ Fitness for Service (FFS)</li> <li>✓ Gas Network &amp; Distribution Design Appraisal</li> <li>✓ Pressure System Safety Regulation compliance</li> </ul>	<ul style="list-style-type: none"> <li>✓ Design Appraisal Services</li> <li>✓ Risk Based Inspection (RBI)</li> <li>✓ HSECCS Performance standards</li> <li>✓ Pipeline Integrity Management</li> <li>✓ Safety Integrity Level (SIL)</li> <li>✓ Structural Analysis</li> </ul>	<ul style="list-style-type: none"> <li>✓ Predictive Maintenance Optimization</li> <li>✓ Rig Inspection &amp; Commissioning Service</li> <li>✓ Lifting Equipment Inspection &amp; Certification</li> <li>✓ Rig Pre-start up Audit</li> <li>✓ Rig Safe to start up Audit</li> </ul>
--	--	--	---

Visit [www.bell-energy.com](http://www.bell-energy.com) to download an Asset Integrity Management case study on a recent project for a Major Oil & Gas producer that resulted in net savings of 197 Million USD.

**Office Locations - Australia | Canada | India | UAE | UK | USA**  
[www.bell-energy.com](http://www.bell-energy.com) | [enquiries@bell-energy.net](mailto:enquiries@bell-energy.net) | (T) +44 (20) 328 713 71

# Progressive Cavity Pumps - API 676 compliance

Matthias Liesenhoff, global market manager, Oil & Gas, Chemical, SEEPEX GmbH, discusses the main issues affecting the compliance of progressive cavity pumps (PCPs) with API 676.

**O**WING TO THEIR operating principle and their roots in waste water treatment, Progressive Cavity Pumps (PCPs) come with typical deviations against petrochemical standard API 676. Some of these deviations are inevitable, others can be remedied.

Progressive cavity pumps are positive displacement pumps that handle fluids gently, with minimal shear or turbulence. They manage fluids of highest viscosity and highest solids content, even abrasive or large particles. They can generate high pressure, 48 bar and more. They are suitable for high vapour pressure (low NPSH) and multiphase fluids. Due to linear curve and low pulsation they are suitable for dosing applications.

In the oil and gas industry, PCPs are often applied to convey sludge or oily water, or in situations where light hydrocarbons raise the vapour pressure to a level where other pump types would cavitate. A forte of PC pumps is vertical semi-submersed installation on a drum; open/closed drain drums or flare knock-out drums are a frequent application.

Historically PCPs are rooted in waste water treatment plants (WWTP). Design and production of typical PCPs are optimised for this market.

Feature	WWTP	Petrochemical / API 676
Operating pressure	max 6 bar, rarely higher	12 to 24 bar, often higher
Design pressure	10 to 16 bar (DIN PN16)	class 150 (19 bar) or class 300 (49 bar)
Flange norm	EN 1092, DIN 2501	ASME B16.5
Shaft sealing	packing gland, component mechanical seal	cartridge mechanical seal API 682
Material of construction	grey cast iron, carbon steel, EN and ISO standards	316L stainless steel, Duplex stainless steel, ASTM standards
Material traceability	not required	at least material certificate 3.1
Casing Drain	not required	flanged casing drain
Drive	integral geared motor	gear and motor separated
Explosion protection	rarely	always
Base plate	simple U-beam	Skid: welded frame with full-length drip pan and lifting lugs
Integration of accessories	rarely	often (API 682 seal plans)
Corrosion protection	low requirements	Highly corrosive environment: ISO 12944 Kat. C4 (Onshore) to C5-M (Offshore)

However, the requirements of petrochemical applications are generally on a higher level. Furthermore, the petrochemical industry is based on US American standards, while most PCP manufacturers are based in Europe.

## Main issues

Manufacturers regularly have to customise and upgrade PCPs for use in oil and gas, which dramatically increases cost and lead time. Two issues give rise to most discussion and customisation:

### 1. Casing design

Typical PCP cast casing do not cover the following requirements:

- design pressure (MACP) > 16 bar, in line with ASME flange ratings or to achieve higher containment pressure for upset conditions
- operating pressure > 12 bar if the pumps operates clockwise
- suction region and discharge region designed for same MACP (API 676 para 6.3.3.2)
- fully ASME compliant flanges (para 6.6)
- nozzle loads per API 676 (para 6.7.1) or higher, which simplifies piping layout
- flanged casing drain (para 6.4.2)
- corrosion resistance exceeding 316 stainless steel
- NORSOK qualification



Image Credit: EagleleBurgmann

PCP vendors typically use universal cartridge seals tailored to the dimensional restrictions.



Bespoke welded constructions with their associated high effort of engineering, procedure approval, fabrication, NDE, inspection and documentation are needed to meet such requirements.

## 2. Shaft seal

PCPs typically have articulate rotor joints to allow for the eccentric rotor movement. A rotor with such joints comes with assembly restrictions that are not compatible with an API 682 mechanical seal. As a result, the mechanical seal can be a heavily engineered seal in the spirit of API 682 at best. PCP vendors typically use universal cartridge seals tailored to the dimensional restrictions.

Other deviations and exceptions are rooted in the PCP principle itself and cannot be avoided:

## 3. Clamping

The progressive cavity principle is based on permanent tight contact (clamping) of a steel rotor and elastomer stator. There is no gap.

- Elastomer cannot be fabricated with the same precision as steel; resulting in performance tolerance exceeding the limits of API 676 (para 8.6.3) which is  $+3/-0$  per cent of characteristic capacity; a PCP can typically manage  $+10/-5$  per cent; tolerance is even higher for small pumps or high pressure.
- The clamping contact makes the stator a wear part to be exchanged at regular intervals that depend on the application and are hard to predict. Non-stop operation over three years (API 676 para 6.1) is not something a PCP can guarantee.

## 4. Eccentric kinematic of the rotor and its impact on vibration

- For a given capacity, vibration levels of a PCP are higher than other API 676 pump types based on concentric motion. A standard PCP may exceed the limit of 3.8 mm/s (para 6.11). This low frequency vibration is inherent in the design and not a sign of trouble.
- Vibration is a limiting factor for vertical semi-submersed PC pumps where the shaft can become several metres long.

## 5. Speed

PCPs typically operate at slow speed 100 - 400 rpm, around 10-20 per cent of a centrifugal pump.

- No need for precise alignment or balancing. PCP baseplates typically omit precision machined pads and jacking screws.
- Shaft bearings are grease lubricated and typically sealed for life. Oil lubrication systems with associated monitoring and cooling are not needed.
- It is common practice to omit dedicated shaft bearings altogether and use the gearbox bearings to support the shaft – this is called “block pump” and it omits also the coupling.
- Shaft seals do not generate much heat by friction. Seal cooling is rarely needed and

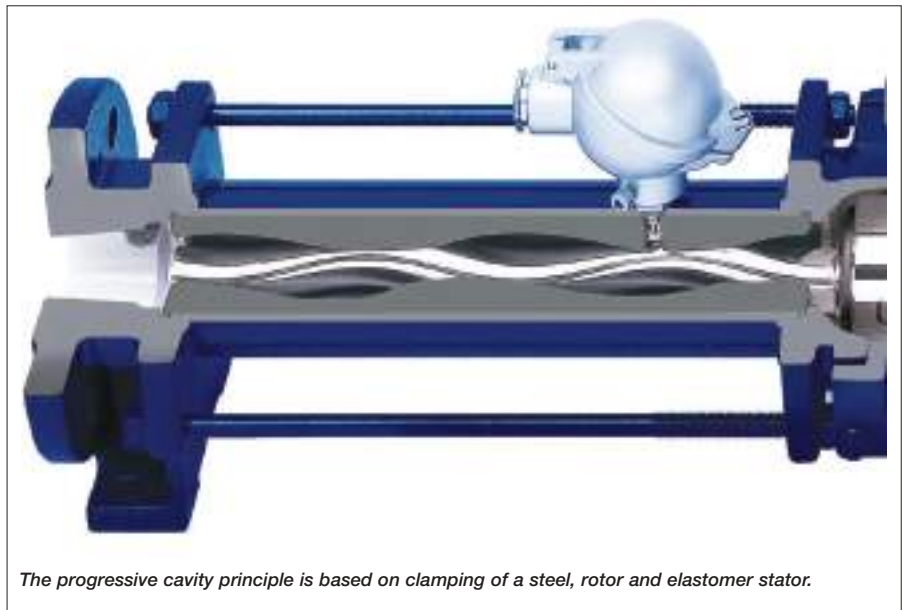

*The progressive cavity principle is based on clamping of a steel, rotor and elastomer stator.*

Image Credit: SEEPEX GmbH

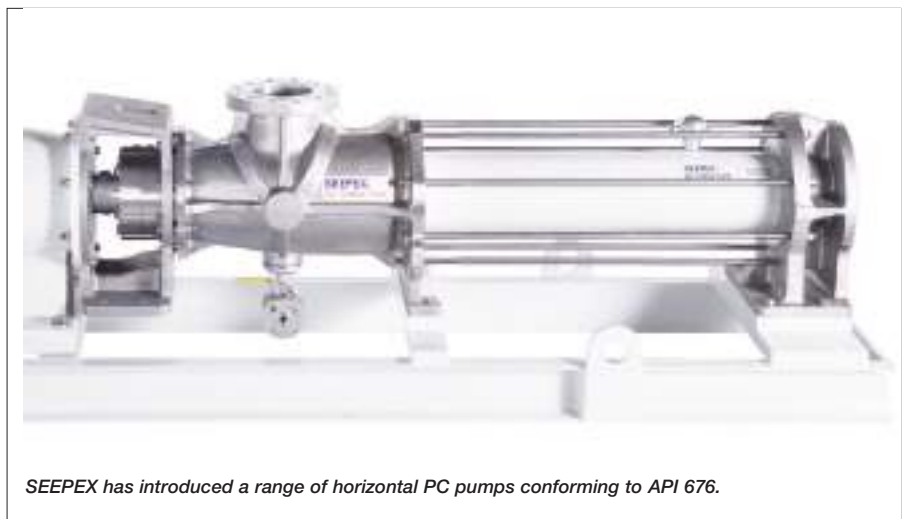

*SEEPEX has introduced a range of horizontal PC pumps conforming to API 676.*

Image Credit: SEEPEX GmbH

standard seal plans offered by PCP vendors may omit the cooler, as a deviation from API 682.

Finally there are exceptions related to US standards:

## 6. Gearbox and bearings

- API 676 references AGMA and ABMA standards and requires gearboxes to conform with AGMA 6010 and API 677
- API 677 gears are not available for the ratings and drive configuration of PCPs
- Outside the Americas the AGMA and ABMA standards are not used. European gear manufacturers will design and calculate to DIN/ISO norm.

## 7. Welding

- API 676 references AWS D1.1 for structural welding
- Welding to AWS is unusual in Europe and unavailable. Welding of structural parts according to ISO standards should be allowed.

## SEEPEX BNA pump range of API 676 compliant pumps

To provide project engineers with smooth sailing and purchasers with favourable price and lead time, manufacturer SEEPEX introduced a range of horizontal PC pumps that are designed based on API 676 – the BNA pump range – with built-in conformity to the key points outlined under 1) and 2) and avoiding welding completely. The main features are:

- heavy-duty cast casing with design pressure 50 bar
- flanges class 300
- standard flanged casing drain
- high nozzle loads
- uncompromised compliance to API 682 for shaft seals
- materials suitable for highly corrosive or harsh environment. ■

*For further information see the website at [www.seepex.com](http://www.seepex.com).*

# Transforming field operations with Artificial Intelligence

Through digital transformation, AI can help unlock efficiency gains across the Middle East's field services management industry, says Mehmood Khan, managing director and vice-president for the Middle East and South Asia at IFS.

**W**HEN A PIECE of equipment breaks down, it can take days or weeks to get it fixed, whether because of diagnostic issues, insufficient resources or time-consuming processes. The situation is compounded in the case of far-flung operations, as in the case of an oil rig off the coast of Abu Dhabi or at a telecommunications tower in the remote Saudi desert. But what if the equipment in question was able to flag up a malfunction and trigger a preventive maintenance alert several days before a system failure forced a halt in production? What if it even requested a technician's visit, and then queued up an invoice for payment?

Beyond that, a little further into the near future, a next-generation system may even be able to automatically plug into a larger network, where it interfaces with human technicians, and as well as a fully automated call centre, self-driving cars, and drone deliveries of parts.

This level of automation is the promise of artificial intelligence (AI) in field services management and can be realised through digital transformation, as the GCC's political and business leaders have already realised. The region's economies are already moving towards AI and advanced technologies, with an estimated impact of US\$320 billion by 2030. Indeed, much of the technology is already available, and in some cases, is already being put to work.

As such, the impact of AI is already being felt in field services management here and around the world. At present, AI use cases are making their way into a variety of software solutions, augmenting automation and helping



*Mehmood Khan, managing director and vice-president for the Middle East and South Asia at IFS.*

to improve service outcomes. However, they remain disconnected from one another. True digital transformation through AI will leverage machine learning across all processes within an organisation, automating systems and making repetitive tasks a distant memory, allowing managers, technicians, and dispatchers to focus on customer engagement and the nuanced complexities best suited to humans' skill sets.

But how do the Middle East's field services companies get to that everything-is-automated stage? Unlocking those efficiency gains is both easier and harder than you think. Here are three recommendations to help you get started on the process:

## Centralise, connect and future-proof your FSM system

This is a necessity for all service firms, wherever they operate. FSM is not meant to be a bolt-on to a CRM. Field service operations are far too complex to cut corners. Your field service management system needs to be the coordinating factor of all touchpoints within your system. Beyond this, it needs to be calibrated to accept whatever the next new technology is, whether it's a new module built off the system itself, or a separate system that integrates with your FSM platform. Smart organisations are taking a cloud-first approach here, allowing for constant updates and easy integration.

## Allow data to flow freely

We can talk ad nauseam about the importance of a solid data science team that cleanses and distributes data insights throughout the business, but more important than that, is simply ensuring that data is written in a common language and freely accessible so that, for instance, if work order history needs to be pulled into an AI system connected to routing management, it can be done quickly and easily.

## Invest in the hardware today

The Internet of Things (IoT) will ultimately be the key to successful utilisation of many AI systems. In manufacturing, this is an easy sell, but what about HVAC repair, telco, home services, and other systems that, as of today, might not yet be calibrated for IoT? The short answer is, even if you don't think the technology is there, it is, and if it's not, it will be in the next five years. It is imperative that forward-thinking companies stay on top of these advancements as they become available and invest smartly. When AI becomes standard practice, everyone's going to be sprinting for your customers. If you want to run with them, you have to start by building the road. In AI-focused economies such as the UAE and Saudi Arabia, that's even more important. ■

“ AI use cases are finding their way into a variety of software solutions.”

# Investment priorities for digital transformation

AVEVA, a global leader in engineering and industrial software, has revealed global survey findings identifying the key investment drivers of digital transformation.

**A**CCORDING TO THE research, which covered 1,240 EMEA, North America and APAC decision makers across nine industry verticals, the Middle East demonstrated less demand for AI (45 per cent vs global mean 75 per cent) and advanced process and engineering design (44 per cent vs global mean 74 per cent). However it led global demand in five technologies, namely:

- 3D visualisation (59 per cent vs global mean 27 per cent)
- IoT / Edge (56 per cent vs global mean 30 per cent)
- Enterprise mobility (51 per cent vs global mean 31 per cent)
- Model simulations (50 per cent vs global mean 25 per cent)
- Laser scanning (41 per cent vs global mean 21 per cent).

“New emerging technologies like AI are taking time to gain traction in the Middle East so the research findings mirror what we are witnessing in the market,” commented Mohamad Awad, regional VP for the Middle East, AVEVA. “AI has the potential to disrupt markets in the Middle East by creating innovative new services and entirely new business models. We are already witnessing its impact in Europe and North America across several industries and market sectors, and we are confident that the trend will follow in the Middle East region. With the eruption of AI, some of the market leaders in five to ten years’ time may be organisations that are not even key players today.”

The research identified three key global investment priorities for organisations when it comes to embarking upon the digital transformation journey:

## 1. Making sense of data utilising artificial intelligence and real time data visualisation

- The research highlighted a strong demand for technologies that provide predictive outputs from large data flows, with AI and Analytics listed as the most important enabler (75 per cent), closely followed by Real-Time Data Visualisation (64 per cent),



Mohamad Awad, regional VP for the Middle East, AVEVA,

Image Credit: AVEVA

Augmented, Virtual or Mixed Reality (60 per cent) and Big Data Processing (59 per cent).

- AI was a top three enabler across all industries globally, with the greatest importance assigned in power and utilities (81 per cent) and oil & gas, particularly upstream (79 per cent) and midstream (78 per cent). Japan, China, the UK and USA prioritised AI the highest.

## 2. Fostering collaboration through advanced process and engineering design

- Advanced process and engineering design was the second most important technology (74 per cent) and was in the top three technology priorities across all industries globally, scoring highest among engineering, procurement and construction professionals.
- This was perceived as an essential technology for global production, ranked as the most important enabler for marine ship building (75 per cent), buildings/infrastructure (74 per cent) and packaged goods (73 per cent), with oil and gas and energy all ranking the technology highly.
- Japan (85 per cent) and Germany (82 per cent) are early adopters, with high importance attributed across all regions.

## 3. Stepping up cyber security and safety capabilities

- Cyber security was the third most prioritised

technology enabler (71 per cent) and in particular a focus for mining (76 per cent), downstream oil and gas (75 per cent), power and utilities (70 per cent) and marine (70 per cent), and the highest priority for planning and scheduling specialists.

- Improving safety and security through technology investment was a priority across all regions, with the Middle East (68 per cent), Australia (63 per cent) and India (60 per cent) particularly highlighting this issue.

For global corporates, the two most valuable assets are their people and their data. Businesses today have great responsibility to protect employees and customers, with technology that provides the foresight to critical failures before they occur.

Lisa Johnston, CMO, AVEVA commented, “As digital transformation moves to the forefront of the industrial agenda, the power of technology to unify data and break silos is allowing specialists to collaborate and change business models. The world’s most capital-intensive projects, from sustainable energy production and mining to smart factories and connected cities, are now being designed, planned and delivered by global multidisciplinary teams, all connected seamlessly through technology.”

Other findings from the research included:

- Asset Performance Managers (APM) were found to have the most demanding desires for technology investment, requiring a far-reaching product set and visionary approach;
- Face-to-face engagement and trust remain key vectors for driving sales success;
- Delivering cost reduction and enhancing safety are prioritised by high growth organisations. China (61 per cent), India (58 per cent) and the Middle East (60 per cent) prioritised cost reduction the most, indicating that significant margin improvement is possible in these geographies from software solutions. This demand for greater efficiency mirrored a requirement to invest in technology to promote safety, as these economies continue to mature. ■



Image Credit: Adobe Stock

*The upper limit on sulphur content of fuel oil for ships has been reduced to 0.5 per cent.*

# The impact of IMO 2020

IMO 2020 is having a significant impact on shipping and refining operations worldwide, but the Middle East is relatively well prepared.

ON 1 JANUARY 2020, IMO 2020 came into force, the International Maritime Organization's global regulation whereby the cap on the sulphur content of fuel oil for ships is reduced to 0.5 per cent from the previous level of 3.5 per cent. The new limit is mandatory for all ships operating outside certain designated emission control areas, where the limit is already 0.10 per cent. It will significantly reduce the amount of sulphur oxides emanating from ships, with major benefits to human health and the environment. From 1 March, carrying non-compliant fuel oil on board ships will be prohibited.

## Significant impact

The new regulation has had a significant impact on ships owners, operators, ports and refiners. The IMO 2020 rules have been estimated to affect more than 3mn bpd of demand for high sulphur fuel oil (HFSO), the shipping industry's traditional fuel. For most ships, it will mean a switch to new types of compliant fuel oils, so-called very low sulphur fuel oil (VLSFO) which are new to the market, or marine gas/diesel oil. Refiners may blend fuel oil with a high (non-compliant) sulphur

content to achieve a compliant fuel oil.

An alternative for ships is to continue to purchase heavy fuel oil, but install exhaust gas cleaning systems or "scrubbers" to reduce the output of sulphur, to meet the requirement. This could be an economically attractive option, as there will be a wide pricing spread between low sulphur compliant fuels and HFSO, notes Alan Gelder, vice president, refining & chemicals at Wood Mackenzie.

**“ In the longer term the industry will rebalance.”**

Despite dire predictions of unavailability of compliant fuels and widespread disruption to maritime transport, the IMO commented that there has been a "relatively smooth transition" to the new limit. Compliant fuels appear to have been readily available, at least at the major fuel bunkering ports. While prices of compliant very low sulphur fuel oil (VLSFO) and marine gas oil (MGO) rose sharply around

the date of implementation, these have now started to stabilise, it noted in a statement on 12 January. However, some concerns remain over issues such as fuel quality and enforcement.

Rick Joswick, head of oil and trade flow analytics, S&P Global Platts, in an article for *Petroleum Economist*, comments that the initial price effects will dissipate over the next few years as refinery conversion expands, more ships add exhaust gas scrubbers and the industry adjusts operations to more efficiently supply low sulphur fuels. In the longer term, the industry will rebalance, with only more modest lasting price effects, he predicts.

The new regulation has had an extensive impact on refinery operations globally, as it requires a major shift in the blendstocks used to make marine fuels, with high sulphur fuel oil being displaced by various low sulphur blends containing both residual and distillate materials, including marine gasoil.

According to a study by Aspentech, there is a shortfall globally in refineries with a focus on clean fuels, with nearly two-thirds of oil refineries globally not having made any capital expenditure against IMO 2020 regulations.

## Middle East in a good place

Middle East refiners, with their more complex refining industries, stand to benefit from the new regulations, being better able to provide the blending components to comply with the new sulphur limits, with high yields of middle distillates.

“So-called complex refineries enjoy the ability to turn a higher percentage of heavier-sourer barrels into valuable petroleum derivatives,” comments Reid I’Anson, global energy economist at Kpler, in *Petroleum Economist*. “Complex refiners – such as those along the US Gulf coast and within Saudi Arabia among others – will also benefit given an inherent process advantage that allows a minimisation of higher sulphur petroleum products.” He notes that Saudi Arabia’s refinery clusters readily compete with the US on complexity and export mix.

Ekaterina Kalinenko, Euro Petroleum Consultants, comments in an article for *Refining & Petrochemicals Middle East*, that a new generation of highly complex plants is radically altering the product mix. Saudi Arabia is spending billions of dollars to construct multiple clean fuel projects, while Kuwait is investing more than US\$30bn to overhaul its refining sector and become the region’s clean fuel leader, she notes.

“MENA exporters of sour crude grades will need to maintain their investment in upgrading refineries or targeting export markets capable of processing their crude in order to remain competitive in a post-IMO world,” notes Edward Bell, commodity analyst at Emirates NBD research.

Fujairah, the region’s leading bunkering hub, is relatively well served with low sulphur fuel oil and has facilities dedicated to loading LFSO. Uniper Energy DMCC’s crude units produce 3.6 mn tonnes/year of ultra low sulphur fuel oil (ULSFO) annually for the marine market, supplying Europe’s ARA and Singapore as well as Fujairah.

Brooge Petroleum with Gas Investment Co

(BPGIC) is building a 250,000 bpd oil refinery in Fujairah to produce compliant bunker fuel, the first phase of which is due to be completed in the first quarter of 2020.

## Transition to low carbon marine fuels

IMO 2020 represents the first step in the transition to low carbon marine fuels. The IMO’s strategy is to cut GHG emissions from shipping by at least 50 per cent by 2050.

To deliver this, significant numbers of zero-carbon ships, or ships that can be easily adapted to use low or zero carbon fuels later in their life, will have to enter the fleet as early as the 2030s, said Kitack Lim, its secretary general, speaking at the World Economic Forum in Davos.

“There is a need to make zero-carbon ships more attractive.”

Stressing the vital role of the IMO as the shipping industry’s global regulator, he said, “Ambitious regulatory targets will act as the catalyst for technology, triggering research, development and innovation,” adding “now is the time to start developing the vessels, the fuels, the delivery mechanisms and all the other necessary infrastructure to support zero-emission shipping.”

This would require collaborative efforts and renewed co-operation from all stakeholders, he said.

The global introduction of alternative fuels and/or energy sources for international shipping will be integral to achieve emissions reduction targets, the IMO comments. “There is a need to make zero-carbon ships more attractive and to direct investments towards innovative sustainable technologies and alternative fuels.”

There is room for all options to be considered, including electric and hybrid power, hydrogen, and other fuel types, the organisation notes. There is also much that can be done to improve energy efficiency of ships through operational measures.

LNG is becoming more widespread as a marine fuel, with the growth in LNG bunkering facilities. S&P Platts forecasts that LNG could take up as much as seven per cent of global bunkering demand by 2030, compared with the current rate of around three per cent. Fujairah is reportedly looking at using LNG as a bunkering fuel and is in discussions with investors.

Alternative fuels such as hydrogen, ammonia and biofuels are at an early stage of development, with more R&D required for them to become economically viable and scaleable. Some interesting initiatives are being explored. CMA CGM and Denmark’s Maersk are piloting biofuel-powered vessels, and a maritime innovation project looking to install the world’s first ammonia-powered fuel cell on a vessel has been awarded Euro10mn funding from the European Union. The ShipFC consortium project will see an offshore vessel owned and operated by Eidesvik, and on contract to energy major Equinor, have a large 2MW ammonia fuel cell retrofitted, allowing it to sail solely on the clean fuel for up to 3,000 hours annually.

“In the next few years, the industry is likely to see a series of arguments between the proponents of LNG, methanol, hydrogen, ammonia and other alternatives about which is best suited to drive the shipping’s energy transition,” comments Jack Jordan, editorial lead, Bunker News for S&P Global Platts, in an article for the *Khaleej Times*. “Those ports that move first in preparing to deliver these newer fuels will have the most to gain from the changes to come over the coming decades.”

Fujairah will need to look at developing a supply chain for alternative fuels if it is to maintain its status among the world’s top bunkering ports, he adds. ■

The use of LNG as a marine fuel is growing.



Image Credit: Adbae Stock



Image Credit: ecom

*Mobile access to data is important for efficiency and employee safety in the field.*

# Digital services for remote device management

The deployment, configuration and continuous updating of mobile devices in companies requires a lot of time and resources. Digital services for staging, mobile device management and device analytics can help to speed up and simplify these processes, says ecom.

IT IS HARD to imagine today's working environment without mobile devices. Especially in the field, mobile access to data, sharing of field data via the corporate network and reliable accessibility are important requirements for smooth processes, as well as employee safety. The use of mobile devices in industrial plants is linked to company-wide guidelines regarding their configuration, integration into the company network, software and, last but not least, data security. Ideally, they should be deployed immediately and updated just-in-time.

Digital services that combine automated staging, device analytics and mobile device management (MDM) can help to overcome this challenge. An MDM system, for example, provides a centralised management of mobile devices. This includes the inventory of mobile devices in organisations, the distribution of software, data and guidelines as well as the protection of data on these devices. Typical solutions include a server component that sends administrative commands to the mobile devices and a client component that runs on the administered device that receives and implements the administrative commands. Deploying an MDM system optimises the functionality and security of mobile devices within an organisation while simultaneously

protecting the closed communications network. Therefore, MDM systems must meet a number of requirements.

## Seamless support for the end user

A well designed MDM system starts with the deployment and configuration of the mobile devices. On request, the Pepperl+Fuchs

“Deploying an MDM system optimises the functionality and security of mobile devices within an organisation.”

brand ecom delivers tablets and smartphones with customised configurations directly from the factory – to different locations and end users worldwide. All security and WLAN settings, as well as pre-definable applications for daily use in industrial plants and hazardous areas, can be pre-installed. This not only enables global rollouts but also makes them

significantly faster and more cost-effective. Error-prone manual configurations are just as much a thing of the past as various device settings.

Providers like ecom also support the zero-touch registration of Android (AZT). This allows Android devices to be deployed quickly, easily and on-demand, with management settings and applications fully customised to the individual employee's needs. This ensures smooth and quick processes. Restricting user access to only authorised applications further increases security. Log-in, provisioning, configuration and management of the devices are possible individually or over-the-air as a group. This also simplifies and accelerates processes.

## Keeping devices up-to-date

An important part of the sustainable use of mobile devices in companies is a continuous supply of up-to-date software and its smooth implementation on the corresponding devices. In order to guarantee updates during normal operation, MDM systems have a "silent" installation, which enables the company's IT to carry out updates remotely in the background and without active user intervention. This is especially beneficial for companies where the IT department is

isolated from the end users as they work in different locations. The only other option is sending the devices back and forth on a regular basis, which is time-consuming and inefficient, or letting the employees install updates on their own, risking them not being carried out correctly. "Silent" installations eliminate these risks. The continuous compliance with IT security standards must also be taken into account. To achieve this, mobile devices should be lockable for private applications, or business apps should only be accessible in a closed and specially secured area on the mobile device. In addition, a regular supply of security patches and updates for the devices must be ensured.

### Failure protection thanks to continuous monitoring

Even well-maintained equipment may be defective due to external influences or due to simple wear and tear. Therefore continuous monitoring of the devices by the IT is indispensable. Proactive alerts and audit reports on the compliance status of equipment help prevent downtime.

With the remote device management functions Device Diagnostics and Device Analytics, ecom provides two solutions which allow the company's IT to permanently

“ Digital solutions such as MDM systems ensure that all devices maintain the same quality.”

monitor the current status of mobile devices. This way, malfunctions can be remedied preventively or directly. Updates during operation are also possible. The live visualisation of network coverage allows administrators to recognise and track critical software events and software installations by the user. Causalities can be generated via a statistical accumulation of events and correlations – for instance between geographical data, WLAN coverage and software errors.

### Enterprise solution with useful functional extensions

Digital solutions such as MDM systems ensure that all devices maintain the same quality. Software upgrades, as well as functional enhancements, are an additional

advantage. Individual user profiles can also be set up. This allows the start and end of the work shift to be displayed, as well as apps, tasks and alarms to be set, for example if a particular piece of work equipment, such as ear protection, is missing. Ecom also provides other optional services like eSentinel, a classic single worker protection solution with alarm function. eBarcode, in turn, offers a professional software solution for data collection. This increases employee productivity and security.

An investment in digital solutions is particularly beneficial for companies that place a wide range of demands on their mobile devices. Digital services and mobile devices must be understood as a holistic system. This system consists of central hardware, closely coordinated peripherals, supporting software and the appropriate platform that is completely tailored to the needs of the user and can be configured modularly for future challenges. ■

*For effective maintenance and guaranteed security of mobile devices, ecom offers various remote device management options for its equipment for hazardous areas. See the website at <https://www.ecom-ex.com/products/digital-products-and-services/solution-portal/>.*

## Volume of data being created by oil and gas companies driving big data solutions

OIL AND GAS assets are increasingly fitted with a multitude of Internet of Things (IoT) sensors, causing exponential growth in data. This, in turn, is increasing the need for adoption of data management solutions for improved operational visibility. This approach helps identify bottlenecks in operations and uncover patterns and relationships across diverse entities, says GlobalData, a leading data and analytics company.

GlobalData's latest thematic report, 'Big Data in Oil & Gas', discusses how growing dependence on data from oil and gas operations is compelling the industry to adopt big data solutions.

Ravindra Puranik, oil and gas analyst at GlobalData, comments, "The oil and gas industry has always generated huge volumes of data daily across the value chain. However, despite being awash with money, it has been poor at data management. It is only when profits drop that the industry starts to investigate how to use data to improve operational efficiency. However, this laissez-faire approach is less prevalent now. Many players, across the value chain, are taking an enterprise-wide view to data, and applying analytics to improve existing business processes and to develop new revenue streams."

Data management is a very complex process, particularly given that much of an oil company's upstream data is created on remote assets and often stored in disparate, disconnected infrastructure. Moreover, there is a paucity of data scientists with a working knowledge of the oil and gas industry.

Puranik continues, "Big data in the oil and gas industry will experience incremental growth once it overcomes these barriers. The growth will be further accelerated by concerns such as falling profit and future uncertainty from renewables.

"The oil and gas industry traditionally relied on paper-based data collection for maintaining records from daily operations. This approach has largely been digitalised now. Effective data management is essential for this approach to succeed so that companies can make better use of their data."

GlobalData's thematic research identifies ADNOC, BP, Chevron, ConocoPhillips, Equinor, ExxonMobil, Gazprom, Rosneft, Repsol, Royal



Image Credit: Adobe Stock

*The oil and gas industry generates huge volumes of data.*

Dutch Shell and Woodside as among the major oil and gas players present in the big data theme.

Oilfield service companies, such as Schlumberger and Baker Hughes, as well as tech giants such as Microsoft and Amazon, are developing industry-specific big data solutions to help oil companies in data management tasks. These solutions can be customised for different operational processes and functions as per the requirements of the oil and gas companies.

Puranik concludes, "The industry generates large volumes of data that require considerable time and substantial computing power to store and analyse. This can be done either by investing in data storage facilities of their own, or shifting to cloud-based solutions. Companies are adopting a combination of both these approaches to manage their data requirements, while also balancing the financial aspects."

*For more information see <https://hot-topics.globaldata.com/big-data>.*

## Intrinsically safe pressure gauges from Keller AG für Druckmesstechnik

KELLER AG FÜR Druckmesstechnik has introduced no less than five intrinsically safe electronic pressure gauges for use in areas subject to gas explosion risks. The type approvals are compliant with the ATEX Explosion Protection Directive regarding explosive gases. The electronic design of these devices is trimmed to minimise energy consumption, so it is also possible to replace the batteries inside areas with explosion risks.

The simplest version, model ECO 1 Ei, offers high resolution and reproducibility for both measuring ranges (-1-30 bar and 0-300 bar), together with accuracy (typical) of 0.5 per cent FS and an integrated min/max memory. The application range as per the ATEX directive is defined by identification markings Ex ia IIC T5 or T6.

Keller's type LEO 1 Ei and LEO 2 Ei electronic pressure gauges feature microprocessor-assisted compensation to ensure an extremely narrow total error band (including temperature errors) of only <0.2 per cent FS over the entire range of operating temperatures from 0-50 °C. The zero point can be selected freely within the four measuring ranges between -1-3 bar and 0-700 bar. An automatic switch-off function guarantees energy efficiency. Both models feature sampling rates of 2 Hz and integrated min/max memories.

The special feature of the LEO 1 Ei is its additional memory for peak values. In peak mode (as it is known), even extremely short-lived peak values for system pressure are registered with a sampling rate of 5,000 Hz. These values are often critical for the lifetimes of hydraulic plants. For both these pressure gauges, the application range as per the ATEX directive is defined by identification markings Ex ia IIC T5 or T6.

Another version of the "Leo" type electronic pressure gauge, the LEO Record Ei, is equipped with an integrated data memory to record pressure and temperature progressions in the measuring medium. Outside of areas with explosion risks, the data can be transmitted via an RS485 interface to a PC, for evaluation with the Logger 4.X software (available free of charge). The LEO Record Ei can register pressures of up to 1,000 bar with a total error band of ±0.1 per cent FS. With a capacitive sensor, this type is also available for very low measuring ranges starting from 30 mbar (±0.2 per cent FS). The application range as per the ATEX directive is defined by identification marking Ex ia IIC T4.

Featuring accuracy of up to 0.01 per cent FS, the LEX 1 Ei electronic pressure gauge is a genuine reference and precision measuring instrument that has been specifically equipped with a five digit display for calibration and testing



Image Credit: Keller AG für Druckmesstechnik

The intrinsically safe pressure gauges.

purposes. Pressure measurement ranges of between -1 bar and 1,000 bar are available. The LEX 1 Ei also offers a min/max memory and a digital interface to generate PC protocols. The application range as per the ATEX directive is defined by identification marking Ex ia IIC T6. Features that are shared by all Keller digital pressure gauges include simple parameterisation and operation with only two buttons. The pressure display can be shown in various physical units that can be selected freely.

## New sensor improves data collection in hazardous areas

SKF HAS GAINED hazardous area approval for its QuickCollect sensor, which collects vibration and temperature data. This allows the sensor to be used in places that would previously have required a 'hot work' permit. The sensor is certified to both the international IECEx and European ATEX standards, for use in Zone 1 hazardous areas. In addition, it is approved for CSA Class 1, Division 2, making it suitable for certain applications in North America.

The certification opens up applications in a range of sectors, including the petrochemicals, mining and marine industries. It also brings digitalisation of data into hazardous areas, which up to now is a relative rarity.

The QuickCollect sensor can be used in conjunction with SKF's ProCollect mobile app, which connects the sensor to SKF's web-based software platform, Enlight Centre. Together, this creates a portable condition monitoring system, called SKF Enlight ProCollect, that offers direct access to SKF's experts in remote diagnostic services.

Monitoring hazardous areas has traditionally been handled manually, due to a lack of certified equipment. Now, fully automated predictive maintenance can be introduced in a straightforward way. This streamlines data collection, spots errors and faults quickly, and can banish the use of 'legacy' paperwork systems.



The sensor brings digitalisation of data into hazardous areas.

"It helps customers bring digitalisation to the most extreme environments of their operations, while improving their Key Performance Indicators (KPIs)," said Barrie Rodgers, product line manager for Mobile Solutions at SKF.

The solution is scalable and can cover only a few assets in a small area or can be introduced to an area with hundreds of assets.

"The package will typically be used on rotating machinery such as pumps and compressors, said Rodgers. "As well as providing vibration and temperature data, it prompts technicians to gather other maintenance information, such as taking a photograph of a component. This gives the analyst more data to provide the correct insights on which to make a decision."

## Honeywell launches new glove line

HONEYWELL HAS LAUNCHED a new line of industrial work gloves – CoreShield™ – with a colour-coded marking system that makes it simple to choose the correct cut protection for work applications according to new EN/ANSI (American National Standards Institute) standards. The CoreShield line comprises 22 models offering cut resistance from A1 to A9 level protection and are woven with a lightweight, high-strength yarn developed by Honeywell.

"Choosing the wrong cut-protective gloves exposes a worker's hands to risk, but it may also cause discomfort and lack of productivity, which can add additional costs," said Miroslav Kafedzhiev, vice president and general manager, Honeywell Productivity and Safety Solutions, Middle East, Russia, Turkey and Africa. "Compared to other work gloves, these offer more comfort and resistance to hand fatigue on a full job shift while providing a spectrum of customised safety against superficial cuts to up to lacerations of the most severe kind."

CoreShield features a high-performance coating with an additional reinforced thumb, providing extended life for the glove and maximum protection for the hand and wrist, and one of the lightest knitted fabrics in the industry. The glass fibre used in most cut-resistant gloves is replaced with a softer, skin-friendly yarn.



Under the Patronage of



Ministry of Health Kuwait



# KUWAIT HEALTH, SAFETY & ENVIRONMENT FORUM 2020

Jumeirah Messilah Beach Hotel & Spa  
Kuwait City, Kuwait

2 - 3 March 2020

In Association with



Kuwait National Guard



Kuwait Fire Services

Prevent | Protect | Prepare



## CONFIRMED SPEAKERS



**Dr. Duaa Alkhaledi**  
Director Occupational Health  
Ministry of Health, Kuwait



**Mazharuddin Shaikh**  
Safety Engineer  
Kuwait Oil Company



**Dr. Ghaida Mubarak Al-Shoraian**  
Senior General Practitioner  
Kuwait National Petroleum Company

## SPONSORS AND PARTNERS

Researched & Developed by

Health, Safety &  
Security Review  
Middle East

Official Media Partners

Oil Review  
TECHNICAL REVIEW

Official Gold Sponsor

中環中區有限公司  
ALFA ABBE PIRELLA MICHELIN S.P.A. GENERAL PARTNER

Demonstration Drill  
Sponsor

VIN  
TECHNOLOGY

Official Communications  
Partner

METCO

Exhibitor

GTSC

CONTACT US:

UK: +44 20 7834 7676 UAE: +971 4 448 9260

E-mail: register@hssreview.me

[www.hse-forum.com](http://www.hse-forum.com)

## ControlAir expands electro-pneumatic valve positioner series for natural gas applications

PRECISION PNEUMATIC AND electro-pneumatic control products manufacturer ControlAir has announced the expansion of the Type 2000 electro-pneumatic valve positioner series to include worldwide safety approvals for use with natural gas when paired with ControlAir's Type 950 explosion-proof I/P transducer.

The natural gas package (CA2022/2023) was designed as an option to deliver safe, stable and accurate control of rotary and linear valves in applications using sweet natural gas in hazardous environments. The CA2022/2023 electro-pneumatic positioner is a NEMA 4X (IP 66) enclosure that provides rugged resistance to severe industrial environments. It is designed for both intrinsic safety and explosion-proof operation.

Natural gas extraction and transport applications in remote locations often do not have access to compressed plant air for operation of pneumatic valve actuators. In this case, natural gas from the pipeline is used to supply the inlet pressure to the CA2022/2023 electro-pneumatic valve positioner that accurately positions the valve stem proportionally to the command of the input signal received from an electric controller. Advanced circuitry includes electronic feedback control for superior vibration protection and highly accurate output.

The high accuracy of the CA2022/2023 electro-pneumatic valve positioner can surpass most control system requirements. Yet because it typically consumes only .05 SCFM (1,415 NI/min) of air in operation, it costs less to buy and to operate as well, according to the manufacturer.

The CA2022/2023 electro-pneumatic valve positioner is suitable for natural gas extraction and transport applications such as natural gas gathering stations, compressor stations, pipeline feed, and booster stations that are located remotely without any access to compressed plant air for operation of pneumatic valve actuators.



Image Credit: ControlAir

Type 2000 electro-pneumatic valve positioner mounted with Type 950 explosion-proof I/P transducer.

## DNV GL presents new standard for site study, engineering, planning and pipeline installation using HDD

DNV GL, A global quality assurance and risk management company, has published a new standard for site investigation, engineering, planning and execution of pipeline installation through horizontal directional drilling (HDD).

The new standard, DNVGL-ST-F121, was created through a joint industry project (JIP) to

provide a series of minimum requirements for all phases, from site investigation, engineering and planning to execution of pipeline installation to reduce the risk associated to HDD crossings.

HDD is a construction method in the trenchless industry which provides significant improvements over traditional open cut methods for installing pipelines beneath obstructions such as rivers, highways and railroads. These include preservation of the ground surface of the construction site, minimal requirement for site preparation and reinstatement, and secure depth of cover.

The 21st Annual Underground Construction magazine HDD survey estimated in 2019 that contractors expected HDD to be applied to nearly half (47 per cent) of their projects.

However, HDD crossings are

complex in nature and always very challenging. It is not uncommon to face problems during execution with significant impact on cost and schedule. The suitable way to overcome this is to ensure a proper investigation, engineering, planning and execution of all drilling-related activities, according to DNV GL.

Additionally, there are currently no methods for in situ repair of damaged pipelines installed by HDD, which makes it even more important to ensure the quality of pipeline design, construction and installation.

"DNV GL brought together a multi-disciplinary group of experts that resulted in a new standard that has established clear parameters, limits and criteria for essential issues related to HDD projects," said Frank Ketelaars, regional manager, Americas, DNV GL – Oil & Gas.



Image Credit: DNV GL

Horizontal drill rig at 16 degrees.

## Emerson application simplifies access to continuous corrosion monitoring data



Image Credit: Emerson

### Plantweb Insight Inline Corrosion application

EMERSON HAS INTRODUCED the Plantweb Insight Inline Corrosion application to provide the oil and gas industry with real-time interpretation and analysis of critical data that helps prioritise maintenance and make informed integrity decisions.

The Plantweb Insight Inline Corrosion application delivers field data from the Roxar wireless corrosion transmitters, providing valuable insight into instrument health and process corrosivity. It offers alerts on preset thresholds for severe corrosivity, probe lifespan for electric resistance (ER) probes, low battery levels and more. The easy-to-read dashboard displays an intuitive heatmap with intelligence on corrosivity of fluid levels based on the NACE standard.

This latest industrial internet of things (IIoT)-based application is capable of seamlessly integrating into existing wireless infrastructures and delivers field data as frequently as once every 15 minutes. By keeping operators updated on changing conditions remotely, the application allows personnel to make fewer manual inspections in the field, minimising their exposure to hazardous areas.

As part of Emerson's Plantweb digital ecosystem, this new application is the latest addition to a scalable and secure portfolio of transformational technologies, software and services that provide relevant personnel with enhanced insight to drive operational excellence.

Easily integrated with a variety of WirelessHART gauges and remote field sensors, Plantweb Insight applications combine continuous, real-time data harvested from Emerson's Pervasive Sensing technologies with predictive analytics to give maintenance and operations personnel actionable, up-to-date process information in any location, improving reliability, safety, production and energy management.

## Gardner Denver field trials new Thunder 5000 HP Quintuplex pump



Gardner Denver's new Thunder 5000 HP Quintuplex pump at STEP energy services field trial.

GARDNER DENVER PETROLEUM & Industrial Pumps (P&IP), the total solutions provider for the drilling, well servicing and frac pumps market, has entered into a six-month field trial of its new Thunder 5000 HP Quintuplex pump, at STEP energy services (STEP) in Alberta, Canada.

Edward Bayhi, vice-president and general manager, Gardner Denver P&IP, said, "The Thunder 5000 HP Quintuplex pump carves a pathway for customers to achieve maximum flow capability in terms of barrels per minute, while also minimising maintenance costs. The pump includes long stroke operating performance based on the previous 3000 model, plus new Thunder fluid end technology designed to significantly improve fluid end life over conventional designs. Our customers will benefit from improved reliability and serviceability."

Dallas McCauley, director, fracturing services, Canada at STEP Energy Services, said, "We chose the Thunder 5000 HP Quintuplex pump because of its 5000 horsepower capability. We are excited to have the opportunity to field trial Gardner Denver's most technologically advanced and robust pump on the market."

During the six-month field trial, STEP will supply weekly operating data for the pump, including discharge pressure, suction pressure, RPM, pounds of proppant, and temperatures. Gardner Denver engineers and service technicians will also regularly assess the pump for periodic field inspections. At the end of the trial, the pump will be returned to Gardner Denver for tear down and inspection.

## Allweiler unveils dosing pump and practical maintenance solution

ALLWEILER, A BUSINESS unit of CIRCOR, has introduced the new AEB-DE dosing pump with flexible and space-saving design as well as OptiFixT, a next-generation progressing cavity pump, designed to reduce service costs.

The products will be presented at Pumps & Valves trade fair in Dortmund, Germany from 12-13 February 2020 (Hall 6, Booth R19-6).

With its quick-change design, the OptiFix progressing cavity pump can save time and money. Its new service solution offers the shortest average repair time in its class,



Ahead of its 160th anniversary, Allweiler launched the next-generation AEB-DE dosing pump series in December 2019.

according to Allweiler. This can result in less downtime, reduced maintenance and lower service costs. OptiFixT can reduce service times by as much as 85 per cent.

The AEB-DE dosing pump features a modular design and has the same installation dimensions for all sizes. This opens up new opportunities for standardisation, easier stock keeping, and straightforward adaptation of pump capacity. The pumps are delivered with high-quality stainless steel casings as standard so they can be used universally.

## TARGET launches MEERA simulation package

TARGET, AN INTERNATIONAL technology and services company focused on delivering digital transformation solutions to data-driven industries, has announced the release of its MEERA simulation package. It combines AI and numerical simulation models in one framework, making it the first AI-Physics augmented reservoir simulator, according to the company.

MEERA simulator is a conventional 3D, 3-phase numerical reservoir simulator, which offers mass conservation for all compositions within the reservoir and wells using flux conserved form of finite volume discretisation for governing Navier-Stokes equations. The actual simulation is performed on a multi-scale grid with arbitrary up-scaled grid block properties.

The AI/ML Engine is a multi-layer deep learning framework having fully connected networks in conjunction with various drop-out layers and coupled with enhanced LSTM based recurrent neural networks.

MEERA simulation package offers up-to-date and reliable remaining hydrocarbon maps to optimise infill drilling locations between FDP cycles.

Swiss Made +

MABI AG - Insulation machinery  
Wendelmasse 10  
D-81806 Weihenstephan / Germany

Tel: +41 (0) 56 463 65 65  
Fax: +41 (0) 56 463 66 66

www.mabi.ch  
E-mail: info@mabi.ch  
Internet: www.mabi.ch

www.mabi.com

# Project Databank

Compiled by Data Media Systems

## OIL, GAS AND PETROCHEMICAL PROJECTS - EGYPT

Project	City	Facility	Budget (\$US)	Status	Project Client	EPC
AMOC - AMOC 2 - Lube Oil	Alexandria	Lube Oil	800,000,000	Feasibility Study Mineral Oils Company	AMOC - Alexandria	Baker Hughes * ENPPI * OneSubsea * Petrojet
ASORC - Hydrocracker	Asyut	Hydrocracker	1,500,000,000	Engineering & Procurement	ASORC - Assiut Oil Refining Co	
ASORC - Hydrocracking Diesel Complex - Overview	Asyut	Hydrocracker	1,800,000,000	Engineering & Procurement	ASORC - Assiut Oil Refining Co	Bechtel Corporation * Subsea 7
ASORC - Naphtha Complex	Asyut	Continuous Catalytic Cracker (CCR)	450,000,000	Construction	ASORC - Assiut Oil Refining Co	Technip
Burullus Gas Company - West Nile Delta Gas Field - Overview	West Nile Delta	Offshore Gas Field	12,000,000,000	Construction	Burullus Gas Company	
Burullus Gas Company - West Nile Delta Gas Field - Phase 2 + Phase 3	West Nile Delta	Offshore Gas Field Development	800,000,000	Construction	Burullus Gas Company Company (EMC - Sun Misr) * Zavkom Group	Egyptian Maintenance
ECHEM - Alexandria Propylene Derivatives Project	Alexandria	Propylene	1,700,000,000	EPC ITB Petrochemicals Holding Company	ECHEM - Egyptian	Technip
ECHEM - Aromatics & Fertilizers Complex (SUPSC Project)	Suez	Aromatics	2,044,000,000	Feasibility Study Petrochemicals Holding Company	ECHEM - Egyptian	
Eni - Block 9 (North Leil Offshore)	Mediterranean Sea	Offshore Oil & Gas Exploration	300,000,000	Engineering & Procurement	Eni	Bechtel Corporation * Subsea 7
ENI - Nooros Exploration Prospect (Abu Madi West)	Nile Delta	Offshore Gas Field	12,000,000,000	Construction	EGPC - Egyptian General Petroleum Corporation * Eni * leoc Production BV * PETROBEL - Belayim Petroleum Company	Eni
Eni - South-West Melehia Block License	South-West Melehia	Exploration	40,000,000	Construction	Eni	Subsea 7
EPPC - Propane Dehydrogenation (PDH) and Polypropylene (PP) Complex - Phase 2	Port Said	Polypropylene	1,200,000,000	Engineering & Procurement	EPPC - Egyptian Company for manufacturing Propylene & Poly Propylene	ENPPI * Petrojet * Technip
MIDOR - Midor Refinery	Alexandria	Refinery	2,200,000,000	Engineering & Procurement	MIDOR - Middle East Oil Refinery	Uhde
Petro Shorouk - Zohr Gas Field Development	Mediterranean Sea	Offshore Gas Field	12,000,000,000	Construction	Petro Shorouk	
Petro Shorouk - Zohr Gas Field Development - Grassroot Natural Gas Processing Plant (Phase 2)	Port Said	Gas Processing	200,000,000	Construction	Petro Shorouk	
PhPC - Atoll Gas Field	Damietta	Offshore Gas Field	300,000,000	Construction	Pharaonic Petroleum Company (PhPC)	Eni
SIDPEC - Polypropylene (PP) Plant	Alexandria	Polypropylene	1,700,000,000	EPC ITB	SIDPEC - Sidi Kreir Petrochemicals Company	Amec Foster Wheeler * ENPPI
SIDPEC - Propane Dehydration (PDH) Plant	Alexandria	Propylene	1,000,000,000	EPC ITB	SIDPEC - Sidi Kreir Petrochemicals Company	ENPPI * Petrojet
SMD - Formaldehyde and Derivatives Project	Damietta	Formaldehyde	41,000,000	Engineering & Procurement	ECHEM - Egyptian Petrochemicals Holding Company * SMD - Suez Methanol Derivatives	Eni

# Stay one step ahead of your competitors

with the DMS Projects Matrix

A critical and essential **business intelligence** tool, updated daily to ensure you are constantly at the top of your **commercial strategies**, allowing you to **maximise your returns** in today's ever **growing global market**.



## REGIONS COVERED

- Asia Pacific
- Middle East
- Latin America
- North America
- Central America
- Russia & CIS
- East Africa
- North Africa
- West Africa
- India
- China
- Europe

## SECTORS COVERED



**SUBSCRIBE TODAY**  
or contact us for further information

- [www.dmsprojects.net](http://www.dmsprojects.net)
- [info@dmsglobal.net](mailto:info@dmsglobal.net)
- +973 1740 5590 (Bahrain Headquarters)
- +971 249 161 71 (UAE office)

# Project Databank

Compiled by Data Media Systems

## Project Focus

Compiled by Data Media Systems

### Project Summary

<b>Project name</b>	Petro Shorouk - Zohr Gas Field Development
<b>Name of Client</b>	Petro Shorouk (joint venture between Eni and Egyptian General Petroleum Corporation)
<b>Estimated Budget (US\$)</b>	12bn
<b>Facility Type</b>	Offshore gas field
<b>Status</b>	Construction
<b>Location</b>	Mediterranean Sea
<b>Project Start</b>	Q3-2015
<b>End Date</b>	Q4-2021
<b>FEED</b>	EniProgetti
<b>Main Contractor</b>	ENPPI, Petroject, OneSubsea, Baker Hughes
<b>Subcontractors</b>	Dresser-Rand, Schneider Electric, Seaway Heavy Lifting, Saipem, Tecnomare, Aker Solutions, Frames, UTEC Survey, PMS - The Petroleum Marine Services Company, Halliburton Company
<b>Contract Value (US\$)</b>	2.4bn

### Background

The field is located in Shorouk Block in the Mediterranean Sea (Egyptian sector), 190 km away from the Egyptian coasts and covers the area of 100 sq km, at a depth of 1,450 m. According to well and seismic information, Zohr could hold a potential of 30 trillion cubic feet of gas and an estimated 5.5 bn bbl of oil. Eni discovered the supergiant natural gas field in August 2015 and was granted approval for the Zohr Development Lease by the EGAS Company in February 2016. The gas produced from the field is expected to be distributed within Egypt, while the excess will be exported to overseas markets. The full field development plan entails the drilling of 254 wells over the field's production life. The overall investment is estimated to be approximately US\$12bn.

### Project Status

Date	Status
Dec 2019	Eni has completed the test operations of the 14th well. Production has reached 3.2 bcf/d.
Aug 2019	The output capacity will reach 2.7bn cubic feet per day (bcf/d) by the end of 2019.
Jul 2019	Eni is planning to drill nine new development wells in the deep waters of the Mediterranean by 2020, to increase the production rates according to the plan with the Ministry of Petroleum.
Feb 2018	The President of Egypt has opened the first phase of the project.

### Project Scope

The project scope includes:

- 3D seismic data acquisition
- processing and interpretation
- The drilling of exploration wells
- Appraisal drilling
- Geological and geophysical studies
- Associated works

### Project Finance

Eni is the field concession owner and the project operator.

Eni: 50 per cent

Rosneft: 30 per cent

BP: 10 per cent

Mubadala: 10 per cent

## Middle East & North Africa

The Baker Hughes Rig Count tracks industry-wide rigs engaged in drilling and related operations, which include drilling, logging, cementing, coring, well testing, waiting on weather, running casing and blowout preventer (BOP) testing.

Country	THIS MONTH			VARIANCE From Last Month	LAST MONTH		
	Land	OffShore	Total		Land	OffShore	Total
<b>Middle East</b>							
ABU DHABI	42	22	64	2	41	21	62
DUBAI	0	2	2	0	0	2	2
IRAQ	77	0	77	0	77	0	77
JORDAN	0	0	0	0	0	0	0
KUWAIT	50	0	50	2	48	0	48
OMAN	53	0	53	0	53	0	53
PAKISTAN	15	0	15	-3	18	0	18
QATAR	4	10	14	0	4	10	14
SAUDI ARABIA	98	17	115	8	95	12	107
SUDAN	6	0	6	0	6	0	6
SYRIA	0	0	0	0	0	0	0
YEMEN	1	0	1	0	1	0	1
<b>TOTAL</b>	<b>346</b>	<b>51</b>	<b>397</b>	<b>9</b>	<b>343</b>	<b>45</b>	<b>388</b>

### North Africa

ALGERIA	42	0	42	3	39	0	39
EGYPT	23	8	31	3	20	8	28
LIBYA	14	2	16	0	14	2	16
TUNISIA	2	0	2	0	2	0	2
<b>TOTAL</b>	<b>81</b>	<b>10</b>	<b>91</b>	<b>6</b>	<b>75</b>	<b>10</b>	<b>85</b>

Source: Baker Hughes

## الأولوية القصوى

على الرغم من أن شركة أرامكو قد تنكر أنها تكتف من جهودها لتحقيق الاستدامة في مواجهة المزيد من التدقيق من جانب المستثمرين، فلا شك أن حركة الاكتتاب العام الأولي تدفع بالمجموعة إلى دائرة الضوء. وهذا من شأنه أن يدفع الأهداف البيئية إلى مرتبة عالية على رأس جدول الأعمال.

وقد أشار ناصر، في إيضاحات الاكتتاب العام الأولي إلى هذا الموضوع قائلاً: «بالاعتماد على موقعنا بين أقل مصادر النفط الخام كثافة في انبعاثات الكربون على مستوى العالم، تهدف شركة أرامكو السعودية إلى تنمية استدامة أعمالنا من خلال الاستفادة من التكنولوجيا والإبداع من أجل الحد من التأثيرات المناخية». وأضاف: «نقوم بنشر التكنولوجيا بهدف إنتاج النفط والغاز بشكل أكثر كفاءة وموثوقية واستدامة». ومع متوسط إنتاج يوس من النفط الخام يبلغ 10 ملايين برميل يومياً، فضلاً عن الوعي العام الجديد لإدارة الإنتاج، فسيكون الرضا على أرامكو أن تستمر على المسار نفسه لفترة طويلة قادمة. ومع ذلك، يعرف المستثمرون جيداً عندما يكون ذلك، فقد أسفرت فرصة الاستفادة من ثروات المملكة النفطية عن تجاوز الشريحة المؤسسية للاكتتاب العام بمقدار ثلاثة أمثال تقريباً. وفي مواجهة تغير المناخ، بل وحتى «الطوارئ المناخية»، لا تزال الأموال تقول كلمتها في عالم النفط والغاز. وفي نهاية المطاف، فإن اكتساب حصة من الاحتياطيات السائلة المؤكدة لدى المملكة العربية السعودية، وهي تبلغ 227 مليار برميل - والتي تمثل خمسة أضعاف الاحتياطيات السائلة المؤكدة لدى الشركات الخمس الكبرى - يمثل فرصة جيدة للغاية لكي تخفض.

شويبه وإزالته، وهذا يتضمن خفض الانبعاثات الكربونية الناجمة عن عملياتها مع خفض الانبعاثات الغازية سنوياً منذ هياييات القرن العشرين، والالتزام بالقضاء عليها تماماً بحلول عام 2030.

## مبادرات أخرى

ليس من الصعب العثور على أمثلة أخرى، ففي حق العثمانية، تقوم أرامكو بحجم 800 ألف طن من ثاني أكسيد الكربون سنوياً لتعزيز استخراج النفط. كما تحكف على دراسة خيارات مختلفة فيما يتعلق بتقليل الانبعاثات الكربونية، بما في ذلك إزالة ثاني أكسيد الكربون من الهواء مباشرة على نطاق صناعي وتعد أنواع الوقود الأكثر نظافة من السمات الرئيسية الأخرى التي تميز محرك الاستثمار لدى قطاع الصناعات التحويلية في المجموعة، فهي بالفعل رابع أكبر مصدرة في العالم، وعلى سبيل المثال، سيلد مشروع الوقود النظيف في مصفاة رأس تنورة المنتجات التي تتوافق مع معايير جودة الوقود والمعايير الأوروبية للانبعاثات (الأورو 6)، وإلى جانب العمليات البحتة التي تجريها، تنشط شركة أرامكو على مجموعة من الجهات الأخرى، مثل التعاون مع الشركات لمصنعة لمحركات السيارات لزيادة الكفاءة إلى أقصى حد من أجل تقليل الانبعاثات الناتجة عن استخدام الوقود الأحفوري. وبالإضافة إلى ذلك، تعمل الشركة مع الشركاء الآخرين على تطوير تقنيات احتجاز الكربون وتخزينه للسيارات والشاحنات، وتمكين طريق ثاني أكسيد الكربون في محطات الوقود من أجل إعادة تدويره إلى شكل آخر من أشكال الطاقة. وتتمثل آخر التطورات في هذا البرنامج في الاختيار الناجح للتكنولوجيا للشاحنات الثقيلة وتحقيق قدرة احتجاز وتخزين تصل إلى 45 في المائة من ثاني أكسيد الكربون المنبعث من حاد المحرك.

كما سلط ناصر الضوء على استعادة ينبع للموائل الطبيعية، والتي تشكل ضرورة أساسية بالنسبة للكتلتات البحرية والطيور، من خلال زراعة غابة من أشجار المانجروف، والتي تعد الحوض الطبيعي الأكثر أهمية لامتصاص ثاني أكسيد الكربون.

## اقتصاد الكربون

هو موضوع واسع النطاق، أصبح أكثر انتشاراً ليس في شركة أرامكو فحسب، ولكن عبر صناعة الطاقة والعالم بأسره. وقد ناقش السيد أحمد الخويطر، كبير مسؤولي التكنولوجيا في أرامكو، فكرة «اقتصاد الكربون الدائري» أثناء وجوده مؤخراً في إحدى الفعاليات التجارية في الهند وقام بتعريف هذا المصطلح على أنه هو الانتقال من نموذج خطي - حيث استخدام المواد ثم التخلص منها إلى نموذج أكثر دائرية من خلال تقليل الاستهلاك وإعادة الاستخدام وإعادة التدوير. وهذا يعني أنه من الضروري السيطرة على انبعاثات ثاني أكسيد الكربون الناتجة من احتراق الهيدروكربونات، ثم إعادة استخدامها ثم إعادة تدويرها في أشكال أخرى من الطاقة لإنتاج دورة الكربون بكفاءة، فضلاً عن الاستفادة من مصادر الطاقة المتجددة مع الكربونية. وأضاف أن الهدف هو تحقيق توازن بين الكربون المنبعث والكمية المخفضة، لمعاد تدويرها، وإزالتها، وذكر الخويطر أن - توازن الكربون هذا هو الترتيب الطبيعي للأشياء. لذا فإنه جعل الاقتصاد متوافقاً مع الطبيعة، بما يعني استعادة توازن الكربون. وهو ما كانت الأرض تقوم به طيلة مليارات السنين، ويعين علينا أن نكون قادرين على محاكاة هذامنا وأضاف أن أرامكو اتخذت بالفعل عدداً من المبادرات لتحرك نحو الاقتصاد الدائري، من خلال تقليل انبعاث ثاني أكسيد الكربون وإعادة



## مفكرة الفعاليات 2020

### فبراير/شباط

- 13 - 11 معرض مصر للبتروكيمياويات - إيجيبت [www.egpc.com](http://www.egpc.com)
- 20 - 18 منتدى الشرق الأوسط لتكنولوجيا التكرير والبتروكيمياويات - 2020 11-13-2020 [www.europepetro.com/events](http://www.europepetro.com/events) - أبو ظبي
- 27 - 25 الأسبوع الدولي للبتروكيمياويات - IP Week [www.ipweek.co.uk](http://www.ipweek.co.uk) - لندن

### مايو/أيار

- 5 - 3 معرض الشرق الأوسط [www.middleeast-energy.com](http://www.middleeast-energy.com) - دبي
- 11 - 9 معرض عُمان للبتروكيمياويات والغاز [www.omanpetroleumandenergyshow.com](http://www.omanpetroleumandenergyshow.com) - مسقط





عام 2018 بلغ معدل كثافة انبعاث الكربون في قطاع التنقيب والإنتاج 10,2 كجم من مكافئ ثاني أكسيد الكربون لكل برميل من مكافئ النفط

## جوانب الاستدامة في أرامكو

نعرض شركة النفط الحكومية في المملكة العربية السعودية الأولية للاستدامة، وذلك في سعيها إلى جذب جيل جديد من المستثمرين. ويعتبر إطلاق نشرة أرامكو السعودية للاكتتاب العام الأولي في بورصة تداول بالرياض بمثابة حدث تاريخي في حد ذاته. كما تعتبر هذه الوثيقة، التي صدرت في نوفمبر/أكتوبر الثاني، دعوة للمستثمرين للمشاركة في الإدراج لسفحة ضخمة للمرة الأولى.

وبتاريخ 15 نوفمبر/تشرين الثاني، أعلنت شركة أرامكو أنها حصلت على جائزة الملك خالد لعام 2019 لاستدامة الشركات. وقد خصت مصفاة ينبع الخاصة بها بالإشادة. وعقب حصولها على الجائزة من الملك سلمان، وصف رئيس مجلس إدارة أرامكو ورئيسها التنفيذي، أمين ناصر بأنها «شركة دولية رائدة» في الصناعة في مجال استدامة الشركات. كما أشار إلى مصفاة ينبع كتمثال على ذلك، وهي مصفاة تكرير بسعة إنتاجية تبلغ 250,000 برميل من النفط الخام في اليوم الواحد. وصرح قائلاً: «إنها نموذج مثالي لمرافق أرامكو السعودية التي تلتزم بالاستدامة في عملياتها الأساسية من خلال استخدام حلول الطاقة ذات الانبعاثات الكربونية المنخفضة، وذلك بتابع التواعد والمعايير في مجالات التشغيل والصيانة والابتكار». وأضاف أن هذا بالإضافة إلى زيادة وهي الموظفين بأهمية الالتزام بالمعايير البيئية والتنفيذ الناجح للمبادرات الاجتماعية والاقتصادية والبيئية، مثل استخدام التكنولوجيا المتقدمة في خلق صناعات تعتمد على الطاقة النظيفة.

على كثافة انبعاث الكربون المنخفضة في إنتاجها من النفط الخام، وهو ما يضعها بين أفضل مصادر النفط الخام كثافة في انبعاث الكربون على مستوى العالم. فقد بلغ معدل كثافة انبعاث الكربون في قطاع التنقيب والإنتاج في أرامكو 10,2 كجم من مكافئ ثاني أكسيد الكربون لكل برميل من مكافئ النفط، وذلك في عام 2018.

### مصفاة ينبع

لقد أصبحت الاستدامة قضية رئيسية بالنسبة لشركة أرامكو وغيرها من منتجي النفط في الأونة الأخيرة، وسط رقابة بيئية شديدة ليس فقط من جانب الناظرين، بل أيضاً من جانب المستثمرين. وفي ظل الاكتتاب العام الأولي، أصبحت شركة أرامكو - للمرة الأولى - في دائرة الضوء في نظر البنوك الكبرى ودور الاستثمار المؤسسي في العالم. ولكن مثلها مثل شركات النفط الأخرى في مختلف أنحاء العالم، كانت منذ فترة طويلة تدمج هذا البعد في أنشطتها التجارية.

وعلى الرغم من أن بيانات اعتماد الإنتاج والربحية لدى شركة النفط ليست موضع شك - إذ أعلنت عن صافي الدخل الذي بلغ 46,9 مليار دولار أمريكي في النصف الأول من عام 2019 - فإنه لا يزال هناك علامات استفهام حول التزامها بالاستدامة والبيئة. وتفتخ شركة أرامكو - وهي أكبر منتج للنفط على مستوى العالم، نحو 10 في المائة من المعروض العالمي - ولكن في عصر تغير المناخ يلقي هذا التضرر بظلال من الشك على ما كان ليحدث لولا ذلك، ولا شك أنه ليس أكثر من تفكير في التوصل إلى اتفاق.

لوفر الأعمال الورقية للاكتتاب العام الأولي مزيداً من الأفكار الثاقبة حول استراتيجية الاستدامة التي تتبناها المجموعة، والتي أصبحت الآن تشكل أولوية إلى جانب أهداف تجارية أخرى. ومع وجود استدامة إيجابية تدور حول إنتاجها الهائل من النفط، فهي أيضاً تسلط الضوء على التأثير المنخفض للكربون لكل برميل من الإنتاج مقارنةً بالمنافسين في قطاع التنقيب والإنتاج. وقد ذكرن وثيقة الاكتتاب العام ما يلي: «تسعى الشركة إلى الحفاظ

المحررة: لويز ووترز

فريق التحرير والتصميم: برانشانت إيه بيدي هيرتاي بارو، فييام بروتكوفلا،  
الجانان جاي إس، رونيكا باتلاك، سامانتا بين، راؤول بوتفيلدو، نكاس فالساماكس،  
فانيس فيرنونجويال، دونيلينا رويلا

محرر المجموعة جوجينا لوبيس

الناشر: نيك فورد هام

مدير مبيعات: مايكل فريديج

مدير مبيعات المجلة: تاندي فينيرا

هاتف: +918 703NEEN3 - بريد إلكتروني: [enquiries@oilreview.com](mailto:enquiries@oilreview.com)

Country	Representative	Telephone	Fax	Email
India	Srinivasa Murthy	(91) 860004488	(91) 86000373	<a href="mailto:srinivasa@oilreview.com">srinivasa@oilreview.com</a>
Japan	Kazu Okano	(81) 363419998		<a href="mailto:kazu@oilreview.com">kazu@oilreview.com</a>
South Africa	Sally Young	(27) 2124 000 961		<a href="mailto:sally@oilreview.com">sally@oilreview.com</a>
UK	Michael Forderham	(44) 203341616	(44)203342876	<a href="mailto:michael.forderham@oilreview.com">michael.forderham@oilreview.com</a>
USA	Michael Forderham	(1) 2022262882	(1) 2022262876	<a href="mailto:michael.forderham@oilreview.com">michael.forderham@oilreview.com</a>

مكتب البريد الرئيسي:  
Alain Charles Publishing Ltd  
University House, 11-13 Lower  
Greenway Place  
London SW1W 0EX UK  
هاتف: +44 (0)2076 9797 656  
فاكس: +44 (0)2076 9797 656

مكتب البريد الرئيسي:  
Alain Charles Middle East FZ LLC  
Office 112, Loob 2H  
ميدان بريند 4-4  
مدينة دبي لإمام  
دبي - الإمارات العربية المتحدة  
هاتف: +971 4 664 9310  
فاكس: +971 4 664 9311

بريد إلكتروني: [production@oilreview.com](mailto:production@oilreview.com)

إشتراكات: بريد إلكتروني: [subscriptions@oilreview.com](mailto:subscriptions@oilreview.com)

رئيس مجلس الإدارة: نيك فورد هام

التوزيع: عالمي - إلكتروني: [circulation@oilreview.com](mailto:circulation@oilreview.com)  
التصميم والإخراج الفني: مكتب مطبع الجار - [design722@print.com](mailto:design722@print.com)  
الطباعة: مطبعة الجارات - دبي

**Alain Charles Publishing**  
Serving the world of business  
© Oil Review Middle East (ISSN) 1169-9310

# المحتويات

## القسم العربي

تحليلات

جوانب الاستدامة في أرامكو ٤

ملخص محتويات القسم الإنجليزي

تقارير خاصة: سوق النفط، مصر

استطلاعات: الغاز، الشحن

تقنيات: اكتشاف ترمب الغاز، الحفر والتشطيب، التقنيات السيبرانية، الاتصالات في المناطق الخطرة

قضايا: معرض مصر للبتروك

## ADVERTISERS INDEX

Company.....	Page	Company.....	Page
Alloy & Stainless Fasteners, Inc.....	29	Oswal Industries Limited.....	28
Bauer Kompressoren GCC FZE.....	27	PAO TMK.....	15
Bell Energy.....	31	Reflex Marine.....	20
Informa Markets (GEO 2020).....	51	Resistotech Industries Pvt Limited.....	9
Keller AG fur Druckmesstechnik.....	2	Saga PCE Private Limited.....	5
Liugong Dressta Machinery sp. z o.o.....	25	Shree Steel Overseas FZCO.....	10
MABI AG.....	43	Suraj Limited.....	13
National Pipe Co. Ltd.....	12	TUBACEX S.A. Group.....	7

Under the Patronage of  
**His Royal Highness  
Prince Khalifa bin Salman Al Khalifa**  
Prime Minister of the Kingdom of Bahrain

REGISTER ONLINE AT  
.....  
**geo-expo.com**  
.....



**60+ COUNTRIES**

**4,000+ ATTENDEES**

**80+ EXHIBITORS**

**450+ SPEAKERS**

# **GEO 2020**

**14<sup>th</sup> Middle East Geosciences  
Conference and Exhibition**

**CONFERENCE:**

**16-19 March 2020**

**EXHIBITION:**

**17-19 March 2020**

**BAHRAIN INTERNATIONAL EXHIBITION & CONVENTION CENTRE**

## **NEW IN 2020**

- Startup Innovation Zone
- Unconventionals Zone
- Digital Transformation, Big Data & AI - Zone
- Academic & University Campus
- Core Display
- Special Sessions

**Download the  
GEO 2020 app**



**SCAN TO  
DOWNLOAD**

HOSTED BY



SUPPORTED BY



CONFERENCE ORGANISERS



ROKIAH  
SOCIETY OF EXPLORATION  
GEOLOGISTS

EXHIBITION ORGANISER



**Informa  
markets**

المجلة العربية للنفط والغاز والبتروكيماويات

# النشرة النفطية

المجلد 23 العدد الأول 2020

ISSN: 1658-6160

الشرق الأوسط

## جوانب الاستدامة في أرامكو

تعطي شركة النفط الحكومية في المملكة العربية السعودية الأولوية للاستدامة، وذلك في سعيها إلى جذب جيل جديد من المستثمرين. بالإضافة إلى أحدث أخبار قطاع النفط والغاز عبر منطقة الشرق الأوسط.